

Data sheet | Item number: 857-304

Relay module; Nominal input voltage: 24 VDC; 1 changeover contact;
Limiting continuous current: 6 A; Yellow status indicator; Module width: 6 mm

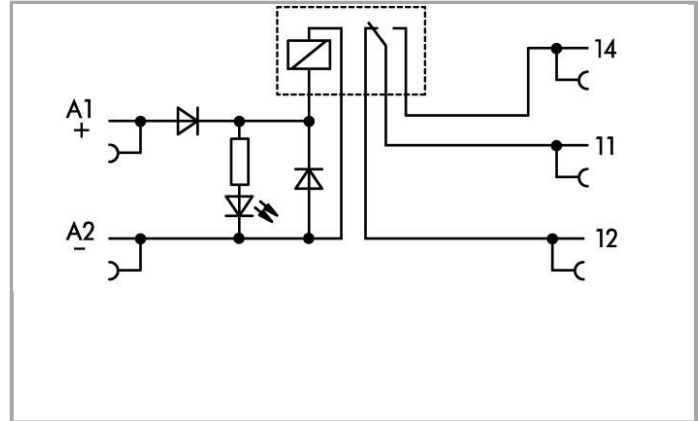

www.wago.com/857-304



RoHS Compliant

BOMcheck.net

Color:

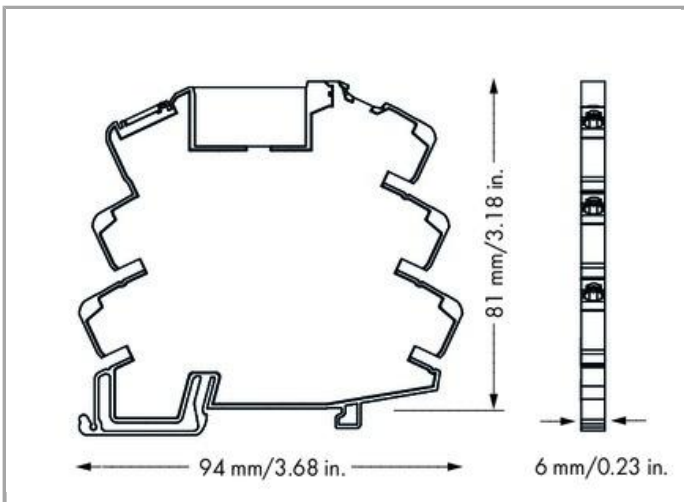

Item description
Short description:



Relay modules with replaceable miniature switching relays for electrical isolation of sensor/actuator level and control/PLC.

WAGO relay modules are supplied in 6 mm-wide housing and share a common profile. The modules feature a single, flexible in-line jumper system (e. g., for supply voltages), eliminating discrete wiring. The pluggable relays can be replaced quickly and easily when needed. An optional interface adapter plugs into the input or output side, enabling 8 modules to be connected in-line via ribbon cable.

The switch status is indicated by an integrated yellow LED.

The device can be labeled using the WAGO WMB Multi marking system.

Note:

Inductive loads have to be attenuated by an appropriate protective circuit in order to protect relay coils and contacts.

Data

Technical Data

Control circuit

Nominal input voltage U_N	24 VDC
Input voltage range	-15 ... +20 %
Nominal input current at U_N	10 mA

Load circuit:

Number of changeover/switchover contacts	1
Contact material	AgSnO ₂
Limiting continuous current	6 A
Max. make current (resistive)	0.02 s 20 A (AC)
Max. switching voltage	250 VAC
Max. switching power (resistive)	1500 VAAC; DC see load limit curve
Switching capacity	AC-15: 3 A / 250 VAC; DC-13: 2 A / 24 VDC
Recommended minimum load	10 V / 10 mA; 24 V / 1 mA
Pull-in time (typ.)	8 ms
Drop-out time (typ.)	4 ms
Electrical life (N.O.; resistive load; 23 °C)	50 x 10 ³ switching operations
Mechanical life (N.O.; resistive load; 23 °C)	5 x 10 ⁶ switching operations
Max. switching load with load/without load	6 min ⁻¹ / 180 min ⁻¹

Signaling

Status indication	LED yellow
-------------------	------------

Safety and protection:

Rated voltage	250 V
Rated impulse voltage	4 kV
Pollution degree	2
Dielectric strength, control/load circuit (AC, 1 min)	4 kV _{rms}
Dielectric strength, control/load circuit (AC, 1 min)	4 kV _{rms}
Dielectric strength open contact (AC, 1 min)	1 kV _{rms}
Dielectric strength open contact (AC, 1 min)	1 kV _{rms}
Degree of protection	IP20

Connection data

Connection technology	Push-in CAGE CLAMP®
Solid conductor	0.34 ... 2.5 mm ² / 22 ... 14 AWG
Fine-stranded conductor	0.34 ... 2.5 mm ² / 22 ... 14 AWG
Strip length	9 ... 10 mm / 0.35 ... 0.39 Inch

Geometrical Data

Width	6 mm / 0.236 inch
Height from upper-edge of DIN-35 rail	81 mm / 3.189 inch
Depth	94 mm / 3.701 inch

Mechanical data

Type of mounting	DIN-35 rail
------------------	-------------

Material Data

Color	gray
Fire load	0.619 MJ
Weight	31.56 g

Environmental Requirements

Surrounding air (storage) temperature	-40 ... 70 °C
Processing temperature	-25 ... +50 °C
Pollution degree	2

Standards and specifications

Standards/specifications	EN 61010-2-201; EN 61810-1; EN 61373; UL 508; GL, ATEX, IEC Ex
--------------------------	--

Elementary relay

WAGO elementary relay

857-152

Commercial data

Country of origin

CN

GTIN

4050821797807

Product Group

6 (Interface Electronics)

Approvals / Certificates

Ex-Approvals

Logo	Approval	Certificate name
	ATEX DEKRA EXAM GmbH	BVS_14_ATEX_E_091_X
	IECEX DEKRA EXAM GmbH	IECEX_BVS_14.0079_X
	UL UL International Germany GmbH (HAZARDOUS LOCATIONS)	E198726 Sec.4 (HAZARDOUS LOCATIONS)
Ship Approvals		
Logo	Approval	Certificate name
	BV Bureau Veritas S.A.	40179_A0
	DNV GL Det Norske Veritas, Germanischer Lloyd	TAA00001D1
	NK Nippon Kaiji Kyokai	TA17255M
	PRS Polski Rejestr Statków	TE/2186/880590/18
	PRS Polski Rejestr Statkow	TE/1989/880590/13





























UL-Approvals















Logo	Approval	Certificate name
	UL UL International Netherlands B.V. (ORDINARY LOCATIONS)	E175199 Sec.4 (ORDINARY LOCATIONS)

Compatible products

Jumper

	Item no.: 281-482 Comb-style jumper bar; insulated; 2-way; IN = IN terminal block	www.wago.com/281-482
	Item no.: 859-402 Push-in type jumper bar; Light gray; Insulated; 18 A; 2-position	www.wago.com/859-402
	Item no.: 859-402/000-005 Push-in type jumper bar; 2-way; Nominal current 18 A; insulated	www.wago.com/859-402/000-005
	Item no.: 859-402/000-006 Push-in type jumper bar; 2-way; Nominal current 18 A; insulated	www.wago.com/859-402/000-006
	Item no.: 859-402/000-029 Push-in type jumper bar; 2-way; Nominal current 18 A; insulated	www.wago.com/859-402/000-029
	Item no.: 859-403 Push-in type jumper bar; Light gray; Insulated; 18 A; 3-position	www.wago.com/859-403
	Item no.: 859-403/000-005 Push-in type jumper bar; 3-way; Nominal current 18 A; insulated	www.wago.com/859-403/000-005
	Item no.: 859-403/000-006 Push-in type jumper bar; 3-way; Nominal current 18 A; insulated	www.wago.com/859-403/000-006
	Item no.: 859-403/000-029 Push-in type jumper bar; 3-way; Nominal current 18 A; insulated	www.wago.com/859-403/000-029
	Item no.: 859-404 Push-in type jumper bar; Light gray; Insulated; 18 A; 4-position	www.wago.com/859-404
	Item no.: 859-404/000-005 Push-in type jumper bar; 4-way; Nominal current 18 A; insulated	www.wago.com/859-404/000-005

	<p>Item no.: 859-404/000-006 Push-in type jumper bar; 4-way; Nominal current 18 A; insulated</p>	www.wago.com/859-404/000-006
	<p>Item no.: 859-404/000-029 Push-in type jumper bar; 4-way; Nominal current 18 A; insulated</p>	www.wago.com/859-404/000-029
	<p>Item no.: 859-405 Push-in type jumper bar; Light gray; Insulated; 18 A; 5-position</p>	www.wago.com/859-405
	<p>Item no.: 859-405/000-005 Push-in type jumper bar; 5-way; Nominal current 18 A; insulated</p>	www.wago.com/859-405/000-005
	<p>Item no.: 859-405/000-006 Push-in type jumper bar; 5-way; Nominal current 18 A; insulated</p>	www.wago.com/859-405/000-006
	<p>Item no.: 859-405/000-029 Push-in type jumper bar; 5-way; Nominal current 18 A; insulated</p>	www.wago.com/859-405/000-029
	<p>Item no.: 859-406 Push-in type jumper bar; Light gray; Insulated; 18 A; 6-position</p>	www.wago.com/859-406
	<p>Item no.: 859-406/000-005 Push-in type jumper bar; 6-way; Nominal current 18 A; insulated</p>	www.wago.com/859-406/000-005
	<p>Item no.: 859-406/000-006 Push-in type jumper bar; 6-way; Nominal current 18 A; insulated</p>	www.wago.com/859-406/000-006
	<p>Item no.: 859-406/000-029 Push-in type jumper bar; 6-way; Nominal current 18 A; insulated</p>	www.wago.com/859-406/000-029
	<p>Item no.: 859-407 Push-in type jumper bar; Light gray; Insulated; 18 A; 7-position</p>	www.wago.com/859-407
	<p>Item no.: 859-407/000-005 Push-in type jumper bar; 7-way; Nominal current 18 A; insulated</p>	www.wago.com/859-407/000-005
	<p>Item no.: 859-407/000-006 Push-in type jumper bar; 7-way; Nominal current 18 A; insulated</p>	www.wago.com/859-407/000-006
	<p>Item no.: 859-407/000-029 Push-in type jumper bar; 7-way; Nominal current 18 A; insulated</p>	www.wago.com/859-407/000-029
	<p>Item no.: 859-408 Push-in type jumper bar; Light gray; Insulated; 18 A; 8-position</p>	www.wago.com/859-408
	<p>Item no.: 859-408/000-005 Push-in type jumper bar; 8-way; Nominal current 18 A; insulated</p>	www.wago.com/859-408/000-005

	Item no.: 859-408/000-006 Push-in type jumper bar; 8-way; Nominal current 18 A; insulated	www.wago.com/859-408/000-006
	Item no.: 859-408/000-029 Push-in type jumper bar; 8-way; Nominal current 18 A; insulated	www.wago.com/859-408/000-029
	Item no.: 859-409 Push-in type jumper bar; Light gray; Insulated; 18 A; 9-position	www.wago.com/859-409
	Item no.: 859-409/000-005 Push-in type jumper bar; 9-way; Nominal current 18 A; insulated	www.wago.com/859-409/000-005
	Item no.: 859-409/000-006 Push-in type jumper bar; 9-way; Nominal current 18 A; insulated	www.wago.com/859-409/000-006
	Item no.: 859-409/000-029 Push-in type jumper bar; 9-way; Nominal current 18 A; insulated	www.wago.com/859-409/000-029
	Item no.: 859-410 Push-in type jumper bar; Light gray; Insulated; 18 A; 10-position	www.wago.com/859-410
	Item no.: 859-410/000-005 Push-in type jumper bar; 10-way; Nominal current 18 A; insulated	www.wago.com/859-410/000-005
	Item no.: 859-410/000-006 Push-in type jumper bar; 10-way; Nominal current 18 A; insulated	www.wago.com/859-410/000-006
	Item no.: 859-410/000-029 Push-in type jumper bar; 10-way; Nominal current 18 A; insulated	www.wago.com/859-410/000-029
ferrule		
	Item no.: 216-241 Ferrule; Sleeve for 0.5 mm ² / AWG 22; insulated; electro-tin plated; electrolytic copper; gastight crimped; acc. to DIN 46228, Part 4/09.90	www.wago.com/216-241
	Item no.: 216-242 Ferrule; Sleeve for 0.75 mm ² / AWG 20; insulated; electro-tin plated; electrolytic copper; gastight crimped; acc. to DIN 46228, Part 4/09.90	www.wago.com/216-242
	Item no.: 216-243 Ferrule; Sleeve for 1 mm ² / AWG 18; insulated; electro-tin plated; electrolytic copper; gastight crimped; acc. to DIN 46228, Part 4/09.90	www.wago.com/216-243
	Item no.: 216-244 Ferrule; Sleeve for 1.5 mm ² / AWG 16; insulated; electro-tin plated; electrolytic copper; gastight crimped; acc. to DIN 46228, Part 4/09.90	www.wago.com/216-244
General accessories		
	Item no.: 209-184 Protection cover	www.wago.com/209-184



Item no.: 249-105
Group marker carrier

www.wago.com/249-105



Item no.: 857-152
Basic relay; Nominal input voltage: 24 VDC; 1 changeover contact; Limiting continuous current: 6 A;
Module width: 5 mm; Module height: 15 mm

www.wago.com/857-152

Marking accessories



Item no.: 2009-110
Marking strips; on reel; not stretchable; plain; snap-on type

www.wago.com/2009-110



Item no.: 2009-115
WMB-Inline; for smartPRINTER; on reel; stretchable 5 - 5.2 mm; plain; snap-on type

www.wago.com/2009-115



Item no.: 2009-115/000-002
WMB-Inline; for smartPRINTER; on reel; stretchable 5 - 5.2 mm; plain; snap-on type

www.wago.com/2009-115/000-002



Item no.: 2009-115/000-006
WMB-Inline; for smartPRINTER; on reel; stretchable 5 - 5.2 mm; plain; snap-on type

www.wago.com/2009-115/000-006



Item no.: 2009-115/000-007
WMB-Inline; for smartPRINTER; on reel; stretchable 5 - 5.2 mm; plain; snap-on type

www.wago.com/2009-115/000-007



Item no.: 2009-115/000-012
WMB-Inline; for smartPRINTER; on reel; stretchable 5 - 5.2 mm; plain; snap-on type

www.wago.com/2009-115/000-012



Item no.: 2009-115/000-017
WMB-Inline; for smartPRINTER; on reel; stretchable 5 - 5.2 mm; plain; snap-on type

www.wago.com/2009-115/000-017



Item no.: 2009-115/000-023
WMB-Inline; for smartPRINTER; on reel; stretchable 5 - 5.2 mm; plain; snap-on type

www.wago.com/2009-115/000-023



Item no.: 2009-115/000-024
WMB-Inline; for smartPRINTER; on reel; stretchable 5 - 5.2 mm; plain; snap-on type

www.wago.com/2009-115/000-024



Item no.: 209-128
Adaptor

www.wago.com/209-128



Item no.: 209-183
Marker card

www.wago.com/209-183



Item no.: 210-110
Fiber-tip pen

www.wago.com/210-110



Item no.: 793-501
WMB marking card; as card; not stretchable; plain; snap-on type

www.wago.com/793-501



Item no.: 793-501/000-002
WMB marking card; as card; not stretchable; plain; snap-on type

www.wago.com/793-501/000-002



Item no.: 793-501/000-005
WMB marking card; as card; not stretchable; plain; snap-on type

www.wago.com/793-501/000-005



Item no.: 793-501/000-006
WMB marking card; as card; not stretchable; plain; snap-on type

www.wago.com/793-501/000-006



Item no.: 793-501/000-007
WMB marking card; as card; not stretchable; plain; snap-on type

www.wago.com/793-501/000-007



Item no.: 793-501/000-012
WMB marking card; as card; not stretchable; plain; snap-on type

www.wago.com/793-501/000-012



Item no.: 793-501/000-017
WMB marking card; as card; not stretchable; plain; snap-on type

www.wago.com/793-501/000-017



Item no.: 793-501/000-023
WMB marking card; as card; not stretchable; plain; snap-on type

www.wago.com/793-501/000-023



Item no.: 793-501/000-024
WMB marking card; as card; not stretchable; plain; snap-on type

www.wago.com/793-501/000-024



Item no.: 793-502
WMB marking card; as card; MARKED; 1 ... 10 (10x); not stretchable; Horizontal marking; snap-on type

www.wago.com/793-502



Item no.: 793-502/000-002
WMB marking card; as card; MARKED; 1 ... 10 (10x); not stretchable; Horizontal marking; snap-on type

www.wago.com/793-502/000-002



Item no.: 793-502/000-005
WMB marking card; as card; MARKED; 1 ... 10 (10x); not stretchable; Horizontal marking; snap-on type

www.wago.com/793-502/000-005



Item no.: 793-502/000-006
WMB marking card; as card; MARKED; 1 ... 10 (10x); not stretchable; Horizontal marking; snap-on type

www.wago.com/793-502/000-006



Item no.: 793-502/000-007
WMB marking card; as card; MARKED; 1 ... 10 (10x); not stretchable; Horizontal marking; snap-on type

www.wago.com/793-502/000-007



Item no.: 793-502/000-012
WMB marking card; as card; MARKED; 1 ... 10 (10x); not stretchable; Horizontal marking; snap-on type

www.wago.com/793-502/000-012



Item no.: 793-502/000-017
WMB marking card; as card; MARKED; 1 ... 10 (10x); not stretchable; Horizontal marking; snap-on type

www.wago.com/793-502/000-017



Item no.: 793-502/000-023
WMB marking card; as card; MARKED; 1 ... 10 (10x); not stretchable; Horizontal marking; snap-on type

www.wago.com/793-502/000-023



Item no.: 793-502/000-024

WMB marking card; as card; MARKED; 1 ... 10 (10x); not stretchable; Horizontal marking; snap-on type

www.wago.com/793-502/000-024



Item no.: 793-503

WMB marking card; as card; MARKED; 11 ... 20 (10x); not stretchable; Horizontal marking; snap-on type

www.wago.com/793-503



Item no.: 793-503/000-002

WMB marking card; as card; MARKED; 11 ... 20 (10x); not stretchable; Horizontal marking; snap-on type

www.wago.com/793-503/000-002



Item no.: 793-503/000-005

WMB marking card; as card; MARKED; 11 ... 20 (10x); not stretchable; Horizontal marking; snap-on type

www.wago.com/793-503/000-005



Item no.: 793-503/000-006

WMB marking card; as card; MARKED; 11 ... 20 (10x); not stretchable; Horizontal marking; snap-on type

www.wago.com/793-503/000-006



Item no.: 793-503/000-007

WMB marking card; as card; MARKED; 11 ... 20 (10x); not stretchable; Horizontal marking; snap-on type

www.wago.com/793-503/000-007



Item no.: 793-503/000-012

WMB marking card; as card; MARKED; 11 ... 20 (10x); not stretchable; Horizontal marking; snap-on type

www.wago.com/793-503/000-012



Item no.: 793-503/000-017

WMB marking card; as card; MARKED; 11 ... 20 (10x); not stretchable; Horizontal marking; snap-on type

www.wago.com/793-503/000-017



Item no.: 793-503/000-023

WMB marking card; as card; MARKED; 11 ... 20 (10x); not stretchable; Horizontal marking; snap-on type

www.wago.com/793-503/000-023



Item no.: 793-503/000-024

WMB marking card; as card; MARKED; 11 ... 20 (10x); not stretchable; Horizontal marking; snap-on type

www.wago.com/793-503/000-024



Item no.: 793-504

WMB marking card; as card; MARKED; 21 ... 30 (10x); not stretchable; Horizontal marking; snap-on type

www.wago.com/793-504



Item no.: 793-504/000-002

WMB marking card; as card; MARKED; 21 ... 30 (10x); not stretchable; Horizontal marking; snap-on type

www.wago.com/793-504/000-002



Item no.: 793-504/000-005

WMB marking card; as card; MARKED; 21 ... 30 (10x); not stretchable; Horizontal marking; snap-on type

www.wago.com/793-504/000-005



Item no.: 793-504/000-006

WMB marking card; as card; MARKED; 21 ... 30 (10x); not stretchable; Horizontal marking; snap-on type

www.wago.com/793-504/000-006



Item no.: 793-504/000-012

WMB marking card; as card; MARKED; 21 ... 30 (10x); not stretchable; Horizontal marking; snap-on type

www.wago.com/793-504/000-012

**Item no.: 793-504/000-017**WMB marking card; as card; MARKED; 21 ... 30 (10x); not stretchable; Horizontal marking; snap-on type www.wago.com/793-504/000-017**Item no.: 793-504/000-023**WMB marking card; as card; MARKED; 21 ... 30 (10x); not stretchable; Horizontal marking; snap-on type www.wago.com/793-504/000-023**Item no.: 793-505**WMB marking card; as card; MARKED; 31 ... 40 (10x); not stretchable; Horizontal marking; snap-on type www.wago.com/793-505**Item no.: 793-505/000-005**WMB marking card; as card; MARKED; 31 ... 40 (10x); not stretchable; Horizontal marking; snap-on type www.wago.com/793-505/000-005**Item no.: 793-505/000-006**WMB marking card; as card; MARKED; 31 ... 40 (10x); not stretchable; Horizontal marking; snap-on type www.wago.com/793-505/000-006**Item no.: 793-505/000-007**WMB marking card; as card; MARKED; 31 ... 40 (10x); not stretchable; Horizontal marking; snap-on type www.wago.com/793-505/000-007**Item no.: 793-505/000-012**WMB marking card; as card; MARKED; 31 ... 40 (10x); not stretchable; Horizontal marking; snap-on type www.wago.com/793-505/000-012**Item no.: 793-506**WMB marking card; as card; MARKED; 41 ... 50 (10x); not stretchable; Horizontal marking; snap-on type www.wago.com/793-506**Item no.: 793-506/000-005**WMB marking card; as card; MARKED; 41 ... 50 (10x); not stretchable; Horizontal marking; snap-on type www.wago.com/793-506/000-005**Item no.: 793-506/000-006**WMB marking card; as card; MARKED; 41 ... 50 (10x); not stretchable; Horizontal marking; snap-on type www.wago.com/793-506/000-006**Item no.: 793-506/000-012**WMB marking card; as card; MARKED; 41 ... 50 (10x); not stretchable; Horizontal marking; snap-on type www.wago.com/793-506/000-012**Item no.: 793-506/000-017**WMB marking card; as card; MARKED; 41 ... 50 (10x); not stretchable; Horizontal marking; snap-on type www.wago.com/793-506/000-017**Item no.: 793-5501**WMB marking card; as card; for terminal block width 5 - 17.5 mm; stretchable 5 - 5.2 mm; plain; snap-on type www.wago.com/793-5501**Item no.: 793-5501/000-002**WMB marking card; as card; for terminal block width 5 - 17.5 mm; stretchable 5 - 5.2 mm; plain; snap-on type www.wago.com/793-5501/000-002**Item no.: 793-5501/000-005**WMB marking card; as card; stretchable 5 - 5.2 mm; plain; snap-on type www.wago.com/793-5501/000-005



Item no.: 793-5501/000-006
WMB marking card; as card; stretchable 5 - 5.2 mm; plain; snap-on type

www.wago.com/793-5501/000-006



Item no.: 793-5501/000-007
WMB marking card; as card; stretchable 5 - 5.2 mm; plain; snap-on type

www.wago.com/793-5501/000-007



Item no.: 793-5501/000-012
WMB marking card; as card; stretchable 5 - 5.2 mm; plain; snap-on type

www.wago.com/793-5501/000-012



Item no.: 793-5501/000-014
WMB marking card; as card; stretchable 5 - 5.2 mm; plain; snap-on type

www.wago.com/793-5501/000-014



Item no.: 793-5501/000-017
WMB marking card; as card; stretchable 5 - 5.2 mm; plain; snap-on type

www.wago.com/793-5501/000-017



Item no.: 793-5501/000-023
WMB marking card; as card; stretchable 5 - 5.2 mm; plain; snap-on type

www.wago.com/793-5501/000-023



Item no.: 793-5501/000-024
WMB marking card; as card; stretchable 5 - 5.2 mm; plain; snap-on type

www.wago.com/793-5501/000-024



Item no.: 793-566
WMB marking card; as card; MARKED; 1 ... 50 (2x); not stretchable; Horizontal marking; snap-on type

www.wago.com/793-566



Item no.: 793-566/000-002
WMB marking card; as card; MARKED; 1 ... 50 (2x); not stretchable; Horizontal marking; snap-on type

www.wago.com/793-566/000-002



Item no.: 793-566/000-005
WMB marking card; as card; MARKED; 1 ... 50 (2x); not stretchable; Horizontal marking; snap-on type

www.wago.com/793-566/000-005



Item no.: 793-566/000-006
WMB marking card; as card; MARKED; 1 ... 50 (2x); not stretchable; Horizontal marking; snap-on type

www.wago.com/793-566/000-006



Item no.: 793-566/000-007
WMB marking card; as card; MARKED; 1 ... 50 (2x); not stretchable; Horizontal marking; snap-on type

www.wago.com/793-566/000-007



Item no.: 793-566/000-012
WMB marking card; as card; MARKED; 1 ... 50 (2x); not stretchable; Horizontal marking; snap-on type

www.wago.com/793-566/000-012



Item no.: 793-566/000-017
WMB marking card; as card; MARKED; 1 ... 50 (2x); not stretchable; Horizontal marking; snap-on type

www.wago.com/793-566/000-017



Item no.: 793-566/000-023
WMB marking card; as card; MARKED; 1 ... 50 (2x); not stretchable; Horizontal marking; snap-on type

www.wago.com/793-566/000-023



Item no.: 793-566/000-024

WMB marking card; as card; MARKED; 1 ... 50 (2x); not stretchable; Horizontal marking; snap-on type

www.wago.com/793-566/000-024

tools



Item no.: 210-720

Operating tool with partially insulated shaft; Type 2, blade (3.5 x 0.5) mm

www.wago.com/210-720

transfer module



Item no.: 857-981

Interface adapter; 14-pole; High-side switching input

www.wago.com/857-981



Item no.: 857-982

Interface adapter; 14-pole; High-side switching output

www.wago.com/857-982



Item no.: 857-986

Interface adapter; 15-pole; High-side switching input

www.wago.com/857-986

Downloads

Documentation

Bid Text

857-304	Apr 5, 2012	DOC	Download
Relaisbaustein		22.0 kB	

Instruction Leaflet

Sockets, relay module, optocoupler module	Jul 7, 2016	PDF	Download
Nominal input voltage 24 VDC, switching current 0.1 A		2.4 MB	

Additional Information

Disposal; Electrical and electronic equipment, Packaging	Oct 15, 2018		Download
		265.8 kB	

CAD files

CAD data

3D Download 857-304		URL	Download
Step file 857-03xx Series	1.0 Jun 30, 2011	STP 299.3 kB	Download



Subject to changes.

WAGO Corporation
Germantown, WI 53022
32423 Minden
Phone: +49571 887-0 | Fax: (262) 255-6222
Email: info.us@wago.com | Web: www.wago.com

Do you have any questions about our products?
We are always happy to take your call at {0}.