

# 4MP VF Vandal-resistant Network IR Fixed Dome Camera

IPC3234LR3-VSP(Z28)-D



## Key Features

### Optics

- Day/night functionality
- SmartIR , up to 30 m (98 ft) IR distance
- IR anti-reflection window to increase the infrared transmittance
- 2D/3D DNR (Digital Noise Reduction)

### Compression

- Ultra 265,H.265, H.264, MJPEG
- Triple streams

### Network

- ONVIF Conformance

## Structure

Wide temperature range: -40°C to 60°C (-40°F to 140°F)

Wide voltage range of ±25%

IK10 vandal resistant

IP67

3-Axis

## Specifications

	IPC3234L3-VSP-D	IPC3234L3-VSPZ28-D			
<b>Camera</b>					
Sensor	1/3", 4.0 megapixel, progressive scan, CMOS				
Lens	2.8~12 mm, manual zoom lens			2.8~12 mm, motorized zoom lens	
DORI Distance	Lens	Detect(m)	Observe(m)	Recognize(m)	Identify(m)
	2.8mm	63	25.2	12.6	6.3
	12mm	270	108	54	27
Angle of View (H)	91.0°~27°				
Angle of View (V)	54.4°~13.7°				
Angle of View (O)	118.3°~33.2°				
Adjustment angle	Pan: 0°~360°		Tilt: 0°~80°		Rotate: 0°~360°
Shutter	Auto/Manual, 1~1/100000 s				
Minimum Illumination	Colour: 0.01Lux (F1.6 AGC ON) 0 Lux with IR				
Day/Night	IR-cut filter with auto switch (ICR)				
Digital noise reduction	2D/3D DNR				
IR Range	Up to 30m (98 ft) IR range				
Defog	Digital Defog				
WDR	DWDR				
<b>Video</b>					
Video Compression	Ultra 265, H.265, H.264, MJPEG				
H.264 code profile	Baseline profile, Main Profile, High Profile				
Frame Rate	Main Stream: 4MP (2048*1520): Max. 20fps; Sub Stream: 720P (1280*720): Max. 30fps; Third Stream: D1 (704*576): Max. 30fps				
HLC	Supported				
BLC	Supported				
OSD	Up to 4 OSDs				
Privacy Mask	Up to 8 areas				
ROI	Up to 2 areas				
Motion Detection	Up to 4 areas				
<b>Network</b>					
Protocols	IPv4, IGMP, ICMP, ARP, TCP, UDP, DHCP, RTP, RTSP, RTCP, DNS, DDNS, NTP, FTP, UPnP, HTTP, HTTPS, SMTP, SSL				

Compatible Integration	ONVIF(Profile S, Profile G, Profile T), API
<b>Interface</b>	
Network	1 RJ45 10M/100M Base-TX Ethernet
Edge Storage	MicroSD, up to 256GB
<b>General</b>	
Power	DC12V±25%, PoE (IEEE802.3 af)
	Power consumption: Max 6W
Dimensions (Ø x H)	Ø148 x 111.3 mm (Ø5.8" x 4.4")
Weight	0.92kg (2.0lb)
Working Environment	-40°C ~ +60°C (-40°F ~ 140°F), Humidity:10%~ 95% RH(non-condensing)
Ingress Protection	IP67
Vandal Resistant	IK10
Reset Button	Supported

## Dimensions

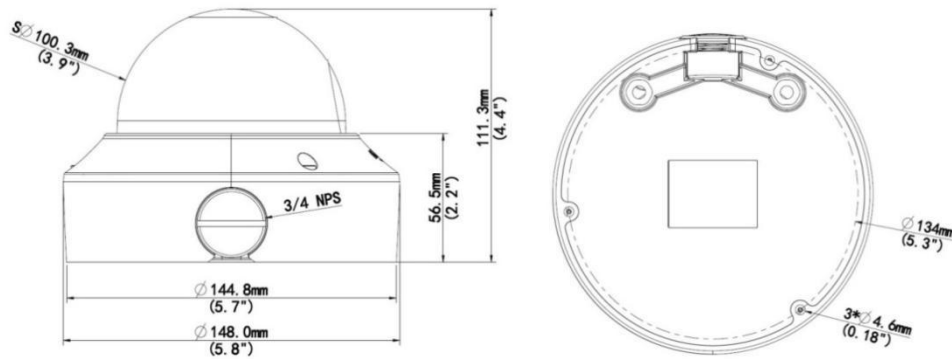

### Zhejiang Uniview Technologies Co., Ltd.

Building No.10, Wanlun Science Park, Jiangling Road 88, Binjiang District, Hangzhou, Zhejiang, China (310051)

Email: [overseasbusiness@uniview.com](mailto:overseasbusiness@uniview.com); [globalsupport@uniview.com](mailto:globalsupport@uniview.com)

<http://www.uniview.com>

©2018 Zhejiang Uniview Technologies Co., Ltd. All rights reserved.

\*Product specifications and availability are subject to change without notice.