

DS-2DY9236I-CWX(T5/316L) 9-inch 2 MP 36 × DarkFighter Explosion Network Position

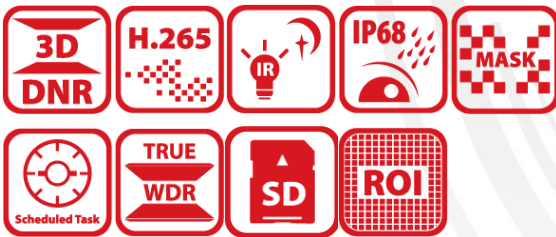

ATEX:

Ex II 2 G Ex db IIC T6 Gb
Ex II 2 D Ex tb IIIC T80°C Db

IECEx:

Ex db IIC T6 Gb
Ex tb IIIC T80°C Db

- 1/1.8" progressive scan CMOS
- Up to 1920 × 1080 @ 30 fps resolution
- Min. illumination: Color: 0.0005 Lux @(F1.2, AGC ON), B/W: 0.0001 Lux @(F1.2, AGC ON), 0 Lux with IR
- 36 × optical zoom, 16 × digital zoom
- 120 dB WDR, HLC, BLC, 3D DNR, Defog, EIS, Regional Exposure, Regional Focus
- Up to 150 m IR distance
- Support H.265+/H.265 video compression



▪ DORI

The DORI (detect, observe, recognize, identify) distance gives the general idea of the camera ability to distinguish persons or objects within its field of view. It is calculated based on the camera sensor specification and the criteria given by EN 62676-4: 2015.

DORI	Detect	Observe	Recognize	Identify
Definition	25 px/m	63 px/m	125 px/m	250 px/m
Distance (Tele)	2965 m (9725.2 ft)	1177 m (3860.6 ft)	593 m (1945 ft)	297 m (974.2 ft)

▪ Specification

Camera	
Image Sensor	1/1.8" progressive scan CMOS
Max. Resolution	1920 × 1080
Min. Illumination	color: 0.0005 Lux @ (F1.2, AGC ON), B/W: 0.0001 Lux @ (F1.2, AGC ON), 0 Lux with IR
Shutter Speed	1/1 s~1/30000 s
Day & Night	ICR
Zoom	36 × optical, 16 × digital
Slow Shutter	yes
Lens	
Focal Length	6.0~216 mm, 36 × optical
FOV	Horizontal field of view: 59° to 1.98° (wide-tele) Vertical field of view: 34.16° to 1.12° (wide-tele) Diagonal field of view: 67.1° to 2.3° (wide-tele)
Focus	Auto/Semi-automatic/Manual
Aperture	F1.2
Zoom Speed	approx. 4.6 s
Illuminator	
Supplement Light Type	IR
Supplement Light Range	150 m
Smart Supplement Light	yes
IR Wavelength	850 nm
PTZ	
Movement Range (Pan)	360° endless
Movement Range (Tilt)	From -90° to 90° (auto flip)
Pan Speed	Configurable, from 0.1°/s to 50°/s, Preset speed: 50°/s
Tilt Speed	Configurable, from 0.1°/s to 40°/s Preset Speed: 40°/s
Proportional Pan	yes
Presets	300
Preset Freezing	yes
Patrol Scan	8 patrols, up to 32 presets for each patrol
Pattern Scan	4 pattern scans, record time over 10 minutes for each scan
Park Action	Preset/Pattern Scan/Patrol Scan/Auto Scan/Tilt Scan/Random Scan/Frame Scan/Panorama Scan
3D Positioning	yes

PTZ Status Display	yes
Scheduled Task	Preset/Pattern Scan/Patrol Scan/Auto Scan/Tilt Scan/Random Scan/Frame Scan/Panorama Scan/Dome Reboot/Dome Adjust/Aux Output
Power-off Memory	yes
Video	
Main Stream	50 Hz: 25 fps (1920 × 1080, 1280 × 960, 1280 × 720) 60 Hz: 30 fps (1920 × 1080, 1280 × 960, 1280 × 720)
Sub-Stream	50 Hz: 25 fps (704 × 576, 640 × 480, 352 × 288) 60 Hz: 30 fps (704 × 480, 640 × 480, 352 × 240)
Third Stream	50 Hz: 25 fps (1920 × 1080, 1280 × 960, 1280 × 720, 704 × 576, 640 × 480, 352 × 288) 60 Hz: 30 fps (1920 × 1080, 1280 × 960, 1280 × 720, 704 × 480, 640 × 480, 352 × 240)
Video Compression	Main Stream: H.265+/H.265/H.264+/H.264 Sub-stream: H.265/H.264/MJPEG Third Stream: H.265/H.264/MJPEG
Video Bit Rate	32 Kbps to 16384 Kbps
H.264 Type	Baseline Profile/Main Profile/High Profile
H.265 Type	Main Profile
Scalable Video Coding (SVC)	Support
Region of Interest (ROI)	8 fixed regions for each stream
Audio	
Audio Compression	G.711alaw, G.711ulaw, G.722.1, G.726, MP2L2,PCM
Audio Bit Rate	64 Kbps (G.711)/16 Kbps (G.722.1)/16 Kbps (G.726)/32-192 Kbps (MP2L2)
Audio Sampling Rate	8 kHz/16 kHz/32 kHz/48 kHz
Environment Noise Filtering	yes
Network	
Protocols	IPv4/IPv6, HTTP, HTTPS, 802.1x, QoS, FTP, SMTP, UPnP, SNMP, DNS, DDNS, NTP, RTSP, RTCP, RTP, TCP/IP, UDP, IGMP, ICMP, DHCP, PPPoE, Bonjour, Websocket, Websockets
Simultaneous Live View	Up to 20 channels
API	Open Network Video Interface (Version 19.12, Profile S, Profile G, Profile T), ISAPI, SDK, ISUP
Smooth Streaming	yes
User/Host	Up to 32 users, 3 user levels: administrator, operator, and user
Security	Password protection, complicated password, HTTPS encryption, 802.1X authentication (EAP-TLS, EAP-LEAP, EAP-MD5), watermark, IP address filter, basic and digest authentication for HTTP/HTTPS, RTP/RTSP over HTTPS, control timeout settings, security audit log, TLS 1.2, TLS 1.3, host authentication (MAC address)
Network Storage	NAS (NFS, SMB/CIFS), auto network replenishment (ANR)
Client	iVMS-4200, HikCentral Pro, Hik-Connect
Web Browser	IE11, Chrome 57+, Firefox 52+, Safari 11+
Image	
Image Parameters Switch	Yes
Image Settings	saturation, brightness, contrast, sharpness, gain, and white balance adjustable by client software or web browser
Day/Night Switch	auto
Wide Dynamic Range (WDR)	120 dB WDR
SNR	≥52 dB

Defog	Optical defog
Image Enhancement	HLC/BLC/3D DNR/Defog/EIS/Regional Exposure/Regional Focus
Privacy Mask	24 programmable polygon privacy masks, mask color or mosaic configurable
Interface	
Ethernet Interface	1 RJ45 10 M/100 M Ethernet
On-board Storage	support microSD/microSDHC/microSDXC cards, up to 256 GB
Audio	1-ch audio input and 1-ch audio output
Alarm	7-ch alarm input and 2-ch alarm output
RS-485	1 RS-485 (Half duplex, HIKVISION, Pelco-P, Pelco-D, self-adaptive)
Event	
Basic Event	Motion detection, video tampering alarm, exception, alarm input and output
Smart Event	Line crossing detection, intrusion detection, region entrance detection, region exiting detection, unattended baggage detection, object removal detection, audio exception detection
Alarm Linkage	Manual tracking, Event tracking
Smart Tracking	Upload to FTP/NAS/memory card, notify surveillance center, send email, trigger alarm output, trigger recording, and PTZ actions (such as preset, patrol scan, pattern scan)
Deep Learning Function	
Face Capture	<ol style="list-style-type: none"> 1. Detects up to 10 faces simultaneously 2. Uploads face with background and closed-up face pictures 3. Support detecting, tracking, capturing, grading, selecting of face in motion, and output the best face picture of the face
General	
Power	100 VAC to 240 VAC Max.100 W (Max. 15 W for IR)
Dimension	451 mm × 258 mm × 507.5 mm (17.76" × 10.16" × 19.98")
Weight	37.6 kg (82.91 lb.)
Material	SUS316L with anti-corrosion surface spray treatment
Operating Condition	-40°C to 60°C (-40°F to 140°F), Working Humidity≤ 90%
General Function	Anti-flicker, heartbeat, mirror, flash log, password reset via e-mail, pixel counter, password protection, one-key reset, three streams
Wiper	Yes
Heater	Yes
Approval	
EMC	FCC (47 CFR Part 15, Subpart B); CE-EMC (EN 55032: 2015, EN 61000-3-2:2019, EN 61000-3-3:2013+A1:2019, EN 50130-4: 2011 +A1: 2014); RCM (AS/NZS CISPR 32: 2015); IC (ICES-003: Issue 7); KC (KN 32: 2015, KN 35: 2015)
Safety	UL (UL 62368-1); CB (IEC 62368-1:2014+A11); CE-LVD (EN 62368-1:2014/A11:2017); BIS (IS 13252(Part 1):2010/ IEC 60950-1 : 2005) LOA (IEC/EN 60950-1)

Environment	CE-RoHS (2011/65/EU); WEEE (2012/19/EU); Reach (Regulation (EC) No 1907/2006)
Protection	IP68, TVS 6000V Lightning Protection, Surge Protection and Voltage Transient Protection
Explosion-Proof Protection	Ex-mark: ATEX: Ex II 2GD Ex db IIC T6 Gb /Ex tb IIIC T80°C Db; IECEx: Ex db IIC T6 Gb /Ex tb IIIC T80°C Db

▪ Available Model

DS-2DY9236I-CWX(T5/316L)

**You are recommended to purchase memory card together with the product if needed. After ordering, the memory card will be installed to product during manufacturing.*

▪ Typical Application

Hikvision products are classified into three levels according to their anti-corrosion performance. Refer to the following description to choose for your using environment.

This model has TOP-LEVEL PROTECTION.

Level	Description
Top-level protection	Hikvision products at this level are equipped for use in areas where professional anti-corrosion protection is a must. Typical application scenarios include coastlines, docks, chemical plants, and more.
Moderate protection	Hikvision products at this level are equipped for use in areas with moderate anti-corrosion demands. Typical application scenarios include coastal areas about 2 kilometers (1.24 miles) away from coastlines, as well as areas affected by acid rain.
No specific protection	Hikvision products at this level are equipped for use in areas where no specific anti-corrosion protection is needed.

▪ Dimension

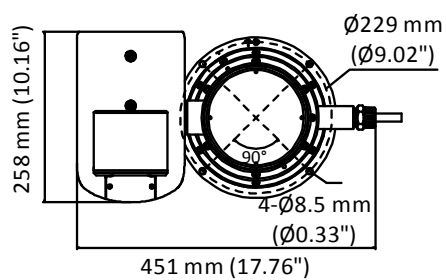
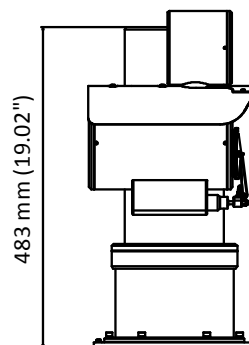
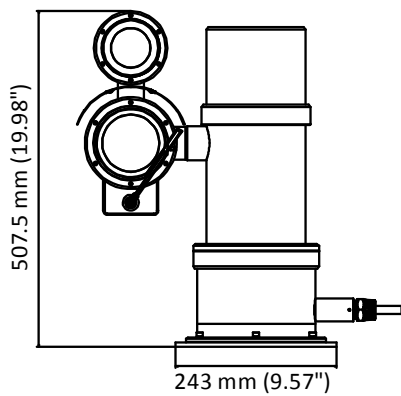

▪ **Accessory**

▪ **Included**

DS-1713ZJ-Y-AC(OS)



Optional

DS-1677ZJ-XS-1.0(D)



DS-2780ZJ-X/316L(OS)



Distributed by

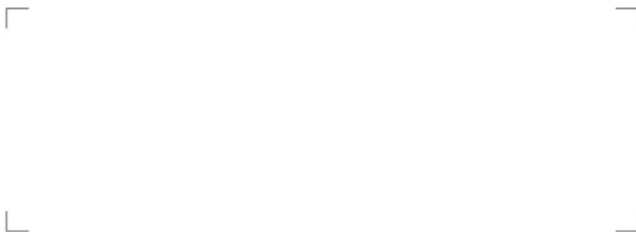

HIKVISION®

Headquarters

No.555 Qianmo Road, Binjiang District,
Hangzhou 310051, China
T +86-571-8807-5998
overseasbusiness@hikvision.com

Hikvision USA
T +1-909-895-0400
sales.usa@hikvision.com

Hikvision Australia
T +61-2-8599-4233
salesau@hikvision.com

Hikvision India
T +91-22-28469900
sales@pramahikvision.com

Hikvision Canada
T +1-866-200-6690
sales.canada@hikvision.com

Hikvision Thailand
T +662-275-9949
sales.thailand@hikvision.com

Hikvision Europe
T +31-23-5542770
sales.eu@hikvision.com

Hikvision Italy
T +39-0438-6902
info.it@hikvision.com

Hikvision Brazil
T +55 11 3318-0050
Latam.support@hikvision.com

Hikvision Turkey
T +90 (216)521 7070- 7074
sales.tr@hikvision.com

Hikvision Malaysia
T +601-7652-2413
sales.my@hikvision.com

Hikvision UK & Ireland
T +01628-902140
sales.uk@hikvision.com

Hikvision South Africa
Tel: +27 (10) 0351172
sale.africa@hikvision.com

Hikvision France
T +33(0)1-85-330-450
info.fr@hikvision.com

Hikvision Kazakhstan
T +7-727-9730667
nikia.panfilov@hikvision.ru

Hikvision Vietnam
T +84-974270888
sales.vt@hikvision.com

Hikvision UAE
T +971-4-4432090
salesme@hikvision.com

Hikvision Singapore
T +65-6684-4718
sg@hikvision.com

Hikvision Spain
T +34-91-737-16-55
info.es@hikvision.com

Hikvision Tashkent
T +99-87-1238-9438
uzb@hikvision.ru

Hikvision Hong Kong
T +852-2151-1761
info.hk@hikvision.com

Hikvision Russia
T +7-495-669-67-99
saleru@hikvision.com

Hikvision Korea
T +82-(0)31-731-8817
sales.korea@hikvision.com

Hikvision Poland
T +48-22-460-01-50
info.pl@hikvision.com

Hikvision Indonesia
T +62-21-2933759
Sales.Indonesia@hikvision.com

Hikvision Colombia
sales.colombia@hikvision.com