

**INSTALLATION AND MAINTENANCE INSTRUCTIONS**



3825 Ohio Avenue, St. Charles, Illinois 60174  
800/736-7672, FAX: 630/377-6495  
www.systemsensor.com

156-2769-020R

**Selectable Output Strobes, Horns, and Horn/Strobes**

For use with the following models: P2R, P2RH, P2RK, P2RHK, P2W, P2WK, P2WH, P2WHK, P4R, P4RH, P4RK, P4W, P4WK, SR, SRH, SRK, SRHK, SW, SWK, SWH, SWHK, SW-CLR-ALERT, PC2R, PC2RH, PC2RK, PC2RHK, PC2W, PC2WK, PC2WH, PC2WHK, PC4R, PC4RH, PC4W, PC4WK, PC4WHK, SCR, SCRH, SCRK, SCRHK, SCW, SCWK, SCWH, SCWHK, SCW-CLR-ALERT, HR, HRK, HW, SR-P, SW-P, SRH-P, SWH-P, P2R-P, P2W-P, P2WH-P, P4R-P, P4W-P, SCW-P, PC2R-P, PC2W-P, PC2WH-P, SRK-P, SRHK-P, P2RK-P, P2RHK-P, SWK-P, SWHK-P, P2WK-P, P2WHK-P, SR-SP, P2R-SP, PC2W-SP, SRK-R, SWK-R, SRHK-R, SWHK-R, P2RK-R, P2WK-R, P2RHK-R, P2WHK-R, SBHK, SBK-R

**NOTE:** All -R models are specifically designed for use with the WTP Series of Weatherproof plates

**NOTE:** When replacing outdoor units; device and back box must be replaced

**NOTE:** Models SBHK, SBK-R are UL listed for General Signaling



**PRODUCT SPECIFICATIONS**

Operating Temperature:	Standard Products	32°F to 120°F (0°C to 49°C)
	K Series	-40°F to 151°F
Humidity Range:	Standard Products	10 to 93% Non-condensing
	K Series	Meets NEMA 4X requirements
Strobe Flash Rate:		1 flash per second
Nominal Voltage:		Regulated 12VDC/FWR or regulated 24DC/FWR
Operating Voltage Range (includes fire alarm panels with built in sync):		8 to 17.5V (12V nominal) or 16 to 33V (24V nominal)
Operating Voltage with MDL3 Sync Module:		8.5 to 17.5V (12V nominal) or 16.5 to 33V (24V nominal)
Input terminal wire gauge:		12 to 18 AWG

**NOTE:** Strobes will operate at 12 V nominal for 15 & 15/75 candela settings only. Switching between ranges is automatic.

**DIMENSIONS FOR PRODUCTS AND ACCESSORIES**

WALL PRODUCTS	Length	Width	Depth	CEILING PRODUCTS	DIAMETER	DEPTH
Strobe and Horn/Strobes (including lens)	5.6"	4.7"	2.5"	Strobes and Horn/Strobes (including lens)	6.8"	2.5"
	142 mm	119 mm	64 mm		173 mm	64 mm
Horns	5.6"	4.7"	1.3"	SA-WBBC Red Weatherproof Back Box	7.1"	2.2"
	142 mm	119 mm	33 mm	SA-WBBCW White Weatherproof Back Box	180 mm	51 mm
SA-WBB Red Weatherproof Back Box	5.7"	5.1"	2.0"	SBBCR Red Surface Mount Box	6.9"	5.3"
SA-WBBW White Weatherproof Back Box	145 mm	130 mm	51 mm	SBBCW White Surface Mount Box	175 mm	135 mm
SBBR Red Surface Mount Box	5.6"	4.7"	4.3"	NOTE: SA-WBB, SA-WBBW, SA-WBBC and SA-WBBCW dimensions do not include the two mounting tabs		
SBBW White Surface Mount Box	142 mm	119 mm	109 mm			

**MOUNTING BOX OPTIONS**

2-Wire Indoor Products	4-Wire Indoor Products	K Series Products
4 × 4 × 1½", Single Gang, Double Gang, 4" Octagon SBBR/W (wall), SBBCR/W (ceiling)	4 × 4 × 1½", Double Gang, 4" Octagon	SA-WBB/W (wall), SA-WBBC/CW (ceiling)

**NOTICE:** This manual shall be left with the owner/user of this equipment.

**GENERAL DESCRIPTION**

The SpectrAlert Advance series of notification appliances offers a wide range of horns, strobes, and horn/strobes, for wall and ceiling applications, indoors and outdoors. They are designed to be used on 12 or 24 volt, DC or FWR (full wave rectified) systems. These products are electrically backward compatible with the previous generation of SpectrAlert notification appliances. Horn/strobe products are available in two versions. The 2-wire products fit systems where a single NAC controls both horn and strobe. The 4-wire products are intended for systems which have separate wiring circuits for the horn and strobe. All SpectrAlert Advance products are suitable for use in synchronized systems. The System Sensor MDL3 module may be used to provide synchronization.

K Series products are designed to be used over a wider range of temperatures and are suitable for use in wet environments with outdoor backbox supplied with product.

**Wall and ceiling products may be used interchangeably (wall products may be used on the ceiling and ceiling products may be used on the wall.)**

**FIRE ALARM SYSTEM CONSIDERATIONS**

The National Fire Alarm Code, NFPA 72, requires that all horns, used for building evacuation produce temporal coded signals. Signals other than those used for evacuation purposes do not have to produce the temporal coded signal. System Sensor recommends spacing notification appliances in compliance with NFPA 72.

**LOOP DESIGN AND WIRING**

The system designer must make sure that the total current drawn by the devices on the loop does not exceed the current capability of the panel supply, and that the last device on the circuit is operated within its rated voltage. The current draw information for making these calculations can be found in the tables within this manual. For convenience and accuracy, use the voltage drop calculator on the System Sensor website (www.systemsensor.com).

When calculating the voltage available to the last device, it is necessary to consider the voltage drop due to the resistance of the wire. The thicker the wire, the smaller the voltage drop. Wire resistance tables can be obtained from electrical handbooks. Note that if Class A wiring is installed, the wire length may be up to twice as long as it would be for circuits that are not fault tolerant.

**NOTE:** The total number of strobes on a single NAC must not exceed 40 for 24 volt applications or 12 for 12 volt applications. Loop resistance on a single NAC should not exceed 120 ohms for 24 volt and 30 ohms for 12 volt systems.

**CANDELA SELECTION**

Adjust the slide switch on the rear of the product to the desired candela setting in the small window on the front of the unit. All products meet the light output profiles specified in the appropriate UL Standards. See Figures 1-3. Use Table 1 to determine the current draw for each candela setting. For K series products used outdoors at low temperatures, listed candela ratings must be reduced in accordance with Table 2.

**NOTE:** SpectraAlert products set at 15 and 15/75 candela automatically work on either 12V or 24V power supplies. The products are not listed for 12V operating voltages when set to any other candela settings. For 4-Wire products, total current draw may be determined by adding current draw for the specific candela selection and the current draw for the specific horn selection use Table 1 and Table 3.

**FIGURE 1. LIGHT OUTPUT - VERTICAL DISPERSION, CEILING TO WALLS TO FLOOR**

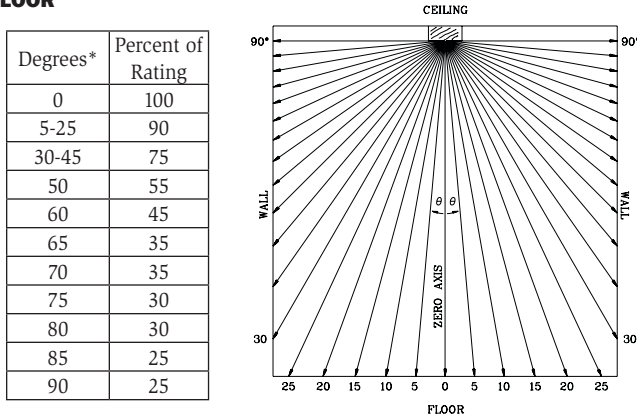

Figures 1-3 list the minimum light output requirements per UL1971.

**FIGURE 2. LIGHT OUTPUT - HORIZONTAL DISPERSION**

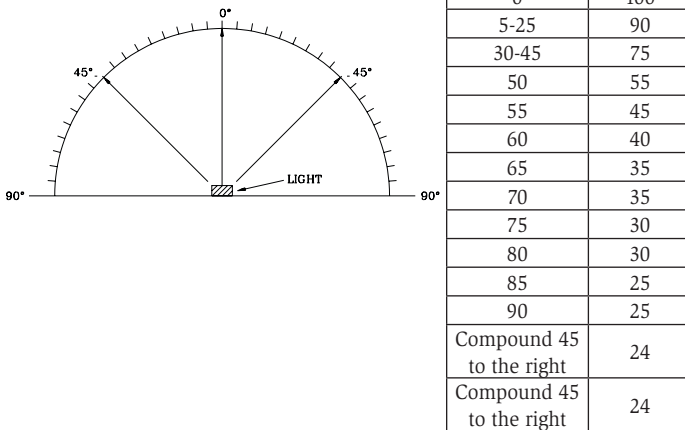

**FIGURE 3. LIGHT OUTPUT - VERTICAL DISPERSION, WALL TO FLOOR**

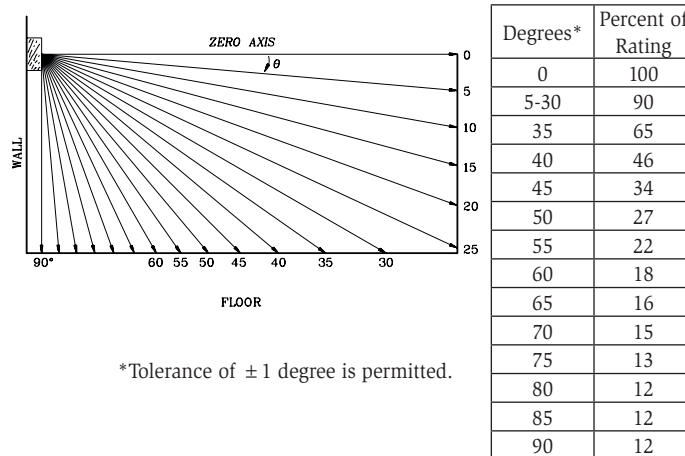

\*Tolerance of ± 1 degree is permitted.

**TABLE 1. STROBE CURRENT DRAW (mA) FOR S, SC, P4 & PC4 SERIES:**

	Candela	8-17.5 Volts		16-33 Volts	
		DC	FWR	DC	FWR
Standard Candela Range	15	123	128	66	71
	15/75	142	148	77	81
	30	NA	NA	94	96
	75	NA	NA	158	153
	95	NA	NA	181	176
	110	NA	NA	202	195
High Candela Range	115	NA	NA	210	205
	135	NA	NA	228	207
	150	NA	NA	246	220
	177	NA	NA	281	251
	185	NA	NA	286	258

**TABLE 2. CANDELA DERATING:**

Listed Candela	Candela rating at -40°F (K Series Outdoor Applications Only)
15	Do not use below 32°F
15/75	
30	
75	44
95	70
110	110
115	115
135	135
150	150
177	177
185	185

**HORN SELECTION**

Turn the rotary switch on the back of the product to the desired setting. For horn and 4-wire horn/strobe products, the current draw for each setting is listed in Table 3. For 2-wire horn/strobe products (P2 series), current draws are listed in Tables 4 and 5. The sound output measurement for each horn setting is shown in Table 6.

**TABLE 3. HORN CURRENT DRAW (mA) FOR H, P4 & PC4 SERIES:**

Pos	Sound Pattern	dA Out	8-17.5 Volts		16-33 Volts	
			DC	FWR	DC	FWR
1	Temporal	High	57	55	69	75
2	Temporal	Medium	44	49	58	69
3	Temporal	Low	38	44	44	48
4	Non-temporal	High	57	56	69	75
5	Non-temporal	Medium	42	50	60	69
6	Non-temporal	Low	41	44	50	50
7	Coded	High	57	55	69	75
8	Coded	Medium	44	51	56	69
9	Coded	Low	40	46	52	50

**NOTE:** In positions 7, 8, and 9, temporal coding must be provided by the NAC. If the NAC voltage is held constant, the horn output will remain constantly on. Positions 7, 8, and 9 are not available on 2-wire horn/strobe products.

**TABLE 4. 2-WIRE HORN/STROBE CURRENT DRAW (  $\eta$  ) FOR P2 AND PC2 STANDARD CANDELA SERIES:**

DC Input	8-17.5 Volts		16-33 Volts						
	15 cd	15/75 cd	15 cd	15/75 cd	30 cd	75 cd	95 cd	110 cd	115 cd
Temporal High	137	147	79	90	107	176	194	212	218
Temporal Medium	132	144	69	80	97	157	182	201	210
Temporal Low	132	143	66	77	93	154	179	198	207
Non-temporal High	141	152	91	100	116	176	201	221	229
Non-temporal Medium	133	145	75	85	102	163	187	207	216
Non-temporal Low	131	144	68	79	96	156	182	201	210
FWR Input									
Temporal High	136	155	88	97	112	168	190	210	218
Temporal Medium	129	152	78	88	103	160	184	202	206
Temporal Low	129	151	76	86	101	160	184	194	201
Non-temporal High	142	161	103	112	126	181	203	221	229
Non-temporal Medium	134	155	85	95	110	166	189	208	216
Non-temporal Low	132	154	80	90	105	161	184	202	211

**TABLE 5. 2-WIRE HORN/STROBE CURRENT DRAW (  $\eta$  ) FOR P2 AND PC2 HIGH CANDELA RANGE SERIES:**

Sound Pattern	16-33 Volts Volts DC				16-33 Volts Volts FWR			
	135 cd	150 cd	177 cd	185 cd	135 cd	150 cd	177 cd	185 cd
Temporal High	245	259	290	297	215	231	258	265
Temporal Medium	235	253	288	297	209	224	250	258
Temporal Low	232	251	282	292	207	221	248	256
Non-temporal High	255	270	303	309	233	248	275	281
Non-temporal Medium	242	259	293	299	219	232	262	267
Non-temporal Low	238	254	291	295	214	229	256	262

**TABLE 6. HORN OUTPUT (  $\beta$  A ) IN UL REVERBERANT ROOM:**

Switch Position	Sound Pattern	dA	8-17.5 Volts**		16-33 Volts**		24 V Nominal Measurements			
							Reverberant		Anechoic	
			DC	FWR	DC	FWR	DC	FWR	DC	FWR
1	Temporal	High	78	78	84	84	88	88	99	98
2	Temporal	Medium	75	75	80	80	86	85	96	96
3	Temporal	Low	71	71	76	76	81	79	94	89
4	Non-temporal	High	82	82	88	88	93	92	100	100
5	Non-temporal	Medium	78	78	85	85	90	89	98	98
6	Non-temporal	Low	73	74	81	81	86	84	96	92
7*	Coded	High	82	82	88	88	93	92	101	101
8*	Coded	Medium	78	78	85	85	90	89	97	98
9*	Coded	Low	74	75	81	81	85	83	96	92

\*Horn & 4-wire Horn/Strobe only. \*\* Minimum dB rating for Operational Voltage Range as per UL 464.

**FIGURE 4. WIRING 2-WIRE PRODUCTS:**

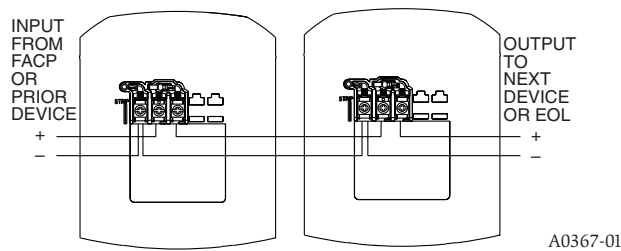

**FIGURE 5. WIRING 4-WIRE PRODUCTS:**

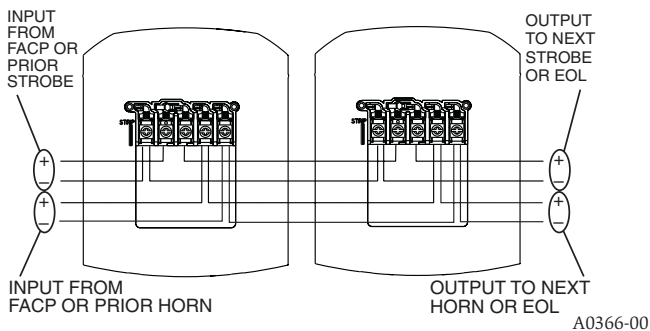

**FIGURE 6. SHORTING SPRING:**

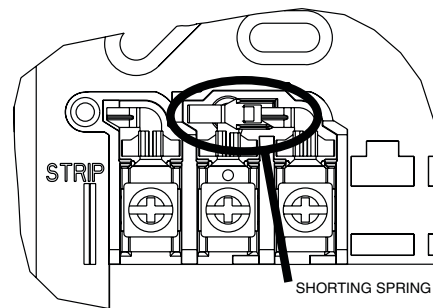

For 4-Wire installations, terminals 1, 2, and 3 connect to the strobe; terminals 4 and 5 connect to the horn. The horn and strobe circuits must be wired independently, and each circuit must be terminated with the appropriate EOL device. Removal of a notification device will result in an open circuit indication on the strobe loop.

**NOTE:** A shorting spring is provided between terminals 2 and 3 of the mounting plate to enable wiring checks after the system has been wired, but prior to installation of the final product. This spring will automatically disengage when the product is installed, to enable supervision of the final system. Only available on indoor products(non K-series).

### MOUNTING INDOOR WALL OR CEILING PRODUCTS

1. Attach mounting plate to junction box as shown in Figure 7. The mounting plate is compatible with 4-inch square, double gang, and 4-inch octagon junction boxes (2-wire products may be used with a single gang box).
2. Connect field wiring to terminals, as shown in Figures 4 or 5.
3. If the product is not to be installed at this point, use the paint cover to prevent contamination of the mounting plate. (For indoor models only)
4. To attach product to mounting plate, remove the paint cover, then hook tabs on the product housing into the grooves on mounting plate.
5. Swing product into position to engage the pins on the product with the terminals on the mounting plate. Make sure that the tabs on the back of the product housing fully engage with the mounting plate.
6. Secure product by tightening the single mounting screw in the front of the product housing. For tamper resistance, the standard captivated mounting screw may be replaced with the enclosed Torx screw.

### SURFACE MOUNT BACK BOX MOUNTING

1. The surface mount back box may be secured directly to the wall or ceiling. Grounding bracket provided if needed.
2. The wall mount box must be mounted with the up arrow pointing up.
3. Threaded knockout holes are provided for the sides of the box for 3/4 inch and 1/2 inch conduit adapter. Knockout holes in the back of the box can be used for 3/4 inch and 1/2 inch rear entry.
4. To remove the 1/2 inch knockout, we recommend you use a flat head screwdriver, place the blade of the flat head screwdriver in the inner edge of the knockout. Strike the screwdriver as you work your way around as shown in Figure 9.

To remove the 3/4 inch knockout place the blade of the screwdriver along the outer edge and work your way around the knockout as you strike the screwdriver, as shown in Figure 9.

NOTE: For both 1/2 in. and 3/4 in. installation, use caution not to strike the knockout near the top edge of the wall version of the surface mount back box.

5. V500 and V700 raceway knockouts are also provided. Use V500 for low profile applications and V700 for high profile applications.
6. To remove the knockout turn pliers up, as shown in Figure 9.

7. Attach the mounting plate to the surface mount back box using the four unpainted screws, as shown in Figure 8.
8. Follow steps 2-6 of the mounting indoor wall or ceiling products to wire and attach the product.

NOTE: For Outdoor Mounting Installation see included Outdoor Mounting Installation Document (I56-3222).

FIGURE 7. MOUNTING:

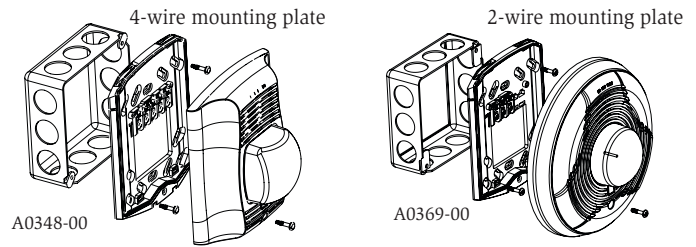

FIGURE 8. SURFACE MOUNT BACK BOX MOUNTING:

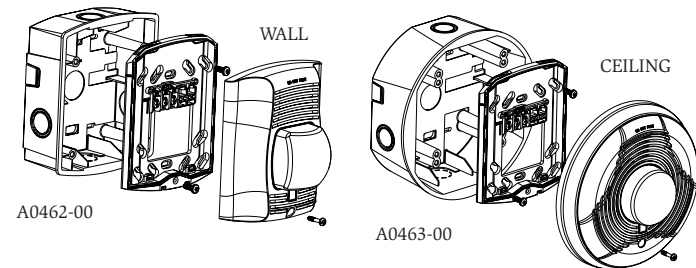
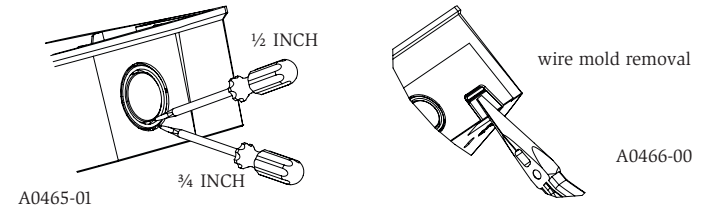

FIGURE 9. KNOCKOUT REMOVAL FOR SURFACE MOUNT BACK BOX:



## Please refer to insert for the Limitations of Fire Alarm Systems

### WARNING

#### THE LIMITATIONS OF HORN/STROBES

**The horn and/or strobe will not work without power.** The horn/strobe gets its power from the fire/security panel monitoring the alarm system. If power is cut off for any reason, the horn/strobe will not provide the desired audio or visual warning.

**The horn may not be heard.** The loudness of the horn meets (or exceeds) current Underwriters Laboratories' standards. However, the horn may not alert a sound sleeper or one who has recently used drugs or has been drinking alcoholic beverages. The horn may not be heard if it is placed on a different floor from the person in hazard or if placed too far away to be heard over the ambient noise such as traffic, air conditioners, machinery or music appliances that may prevent alert persons from hearing the alarm. The horn may not be heard by persons who are hearing impaired.

**NOTE:** Strobes must be powered continuously for horn operation.

**The signal strobe may not be seen.** The electronic visual warning signal uses an extremely reliable xenon flash tube. It flashes at least once every second. The strobe must not be installed in direct sunlight or areas of high light intensity (over 60 foot candles) where the visual flash might be disregarded or not seen. The strobe may not be seen by the visually impaired.

**The signal strobe may cause seizures.** Individuals who have positive photoic response to visual stimuli with seizures, such as persons with epilepsy, should avoid prolonged exposure to environments in which strobe signals, including this strobe, are activated.

**The signal strobe cannot operate from coded power supplies.** Coded power supplies produce interrupted power. The strobe must have an uninterrupted source of power in order to operate correctly. System Sensor recommends that the horn and signal strobe always be used in combination so that the risks from any of the above limitations are minimized.

#### THREE-YEAR LIMITED WARRANTY

System Sensor warrants its enclosed product to be free from defects in materials and workmanship under normal use and service for a period of three years from date of manufacture. System Sensor makes no other express warranty for this product. No agent, representative, dealer, or employee of the Company has the authority to increase or alter the obligations or limitations of this Warranty. The Company's obligation of this Warranty shall be limited to the replacement of any part of the product which is found to be defective in materials or workmanship under normal use and service during the three year period commencing with the date of manufacture. After phoning System Sensor's toll free number 800-SENSOR2 (736-7672) for a Return Authorization number, send defective units postage prepaid to: Honeywell, 12220 Rojas Drive, Suite 700, El Paso TX

79936, USA. Please include a note describing the malfunction and suspected cause of failure. The Company shall not be obligated to replace units which are found to be defective because of damage, unreasonable use, modifications, or alterations occurring after the date of manufacture. In no case shall the Company be liable for any consequential or incidental damages for breach of this or any other Warranty, expressed or implied whatsoever, even if the loss or damage is caused by the Company's negligence or fault. Some states do not allow the exclusion or limitation of incidental or consequential damages, so the above limitation or exclusion may not apply to you. This Warranty gives you specific legal rights, and you may also have other rights which vary from state to state.

#### FCC STATEMENT

SpectraAlert Strobes and Horn/Strobes have been tested and found to comply with the limits for a Class B digital device, pursuant to part 15 of the FCC Rules. These limits are designed to provide reasonable protection against harmful interference when the equipment is operated in a commercial environment. This equipment generates, uses, and

can radiate radio frequency energy and, if not installed and used in accordance with the instruction manual, may cause harmful interference to radio communications. Operation of this equipment in a residential area is likely to cause harmful interference in which case the user will be required to correct the interference at his own expense.