

# Solar Controller

MA-20-12/24  
MA-30-12/24  
MA-40-12/24  
MA-60-12/24  
MA-60-12/24/48

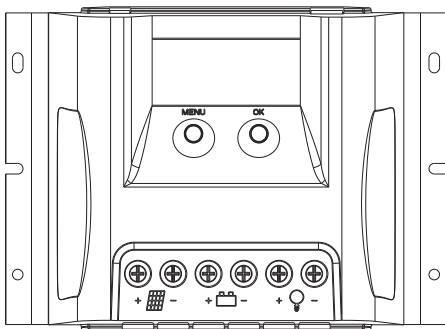

# User Manual

CE, Rohs, ISO9001:2015  
Subject to change without notice!

# Contents

<b>1.Safety instructions and waiver of liability</b> .....	<b>1</b>
1.1 Safety Instructions.....	1
1.2 Liability Exclusion.....	1
<b>2.Product Overview</b> .....	<b>2</b>
<b>3.Dimensions</b> .....	<b>3</b>
3.1 MA-20, 30,40 12/24.....	3
3.2 MA-60-12/24,MA-60-12/24/48.....	4
<b>4.Structure &amp; Accessory</b> .....	<b>5</b>
4.1 Structure & Characteristics of MA-20, 30,40 12/24.....	5
4.2 Structure & Characteristics of MA-60-12/24,MA-60-12/24/48.....	5
4.3 Temperature Sensor.....	6
4.4 RS485.....	6
4.5 Optional Accessories.....	6
<b>5.Installation</b> .....	<b>7</b>
5.1 Installation Notes.....	7
5.2 Mounting Location Requirements.....	7
5.3 Wiring Specifications.....	8
5.4 Connection.....	8
5.5 Grounding.....	9
<b>6.Operation</b> .....	<b>10</b>
6.1 LCD Display.....	10
6.2 Key function.....	12
6.3 Parameters setting.....	13
<b>7.Protections, Troubleshooting and Maintenance</b> .....	<b>15</b>
7.1 Troubleshooting.....	15
7.2 Protection.....	16
7.3 Maintenance.....	16
<b>8.Technical Data</b> .....	<b>17</b>

Dear Clients,

Thank you for purchasing our MA Series Solar PV Charge Controller. Your support and trust in us are much appreciated. Please take time to read this manual, this will help you make full use of the many advantages this controller can provide your PV-System with. This manual presents important recommendations for installing, operating and monitoring. Read it with special care in your own interest and please pay attention to the safety recommendations herein indicated.

## 1, Safety instructions and waiver of liability

### 1.1 Safety Instructions

The following symbols are used throughout this manual to indicate potentially dangerous conditions or mark important safety instructions. Please take care when meeting these symbols.



**WARNING:** Indicates a potentially dangerous condition. Use extreme caution when performing this task.



**CAUTION:** Indicates a critical procedure for safe and proper operation of the controller.



**WARNING:**

- 1) There are no user serviceable parts inside the controller. Do not disassemble or attempt to repair the controller.
- 2) Keep children away from batteries and the charge controller.

### 1.2 Liability Exclusion

The manufacturer shall not be liable for damages, especially on the battery, caused by use other than as intended or as mentioned in this manual or if the recommendations of the battery manufacturer are neglected. The manufacturer shall not be liable if there has been service or repair carried out by any unauthorized person, unusual use, wrong installation, or bad system design.

## 2, Overview

With your new MA series solar charge controller you own a state-of-the art device which was developed according to the latest available technical standards.

**It comes with a number of outstanding features, such as:**

- LCD display design, read operating data and working condition easily
- Real-time energy statistics function
- 12/24/36/48V automatic recognition
- Flexible System battery selection: Liquid, Gel, AGM and Lithium
- Extends battery life through accurate remote temperature sensor
- Controller is protected against over-temperature due to built-in power reduction function
- Four stages battery charging process: fast, boost, equalization, float
- Multiple load control modes: Always on, Street lamp, User-define Mode
- Two USB interfaces (MA-20, 30,40 12/24)
- IoT wireless communication or Bluetooth communication functions optional (MA-60-12/24 and MA-60-12/24/48)
- Based RS-485 standard Modbus protocol with RJ11 interface to maximize the communication needs of different occasions (MA-60-12/24 and MA-60-12/24/48)
- Perfect EMC & thermal design
- Full automatic electronic protect function

## 3, Dimensions

### 3.1

MA-20-12/24

MA-30-12/24

MA-40-12/24

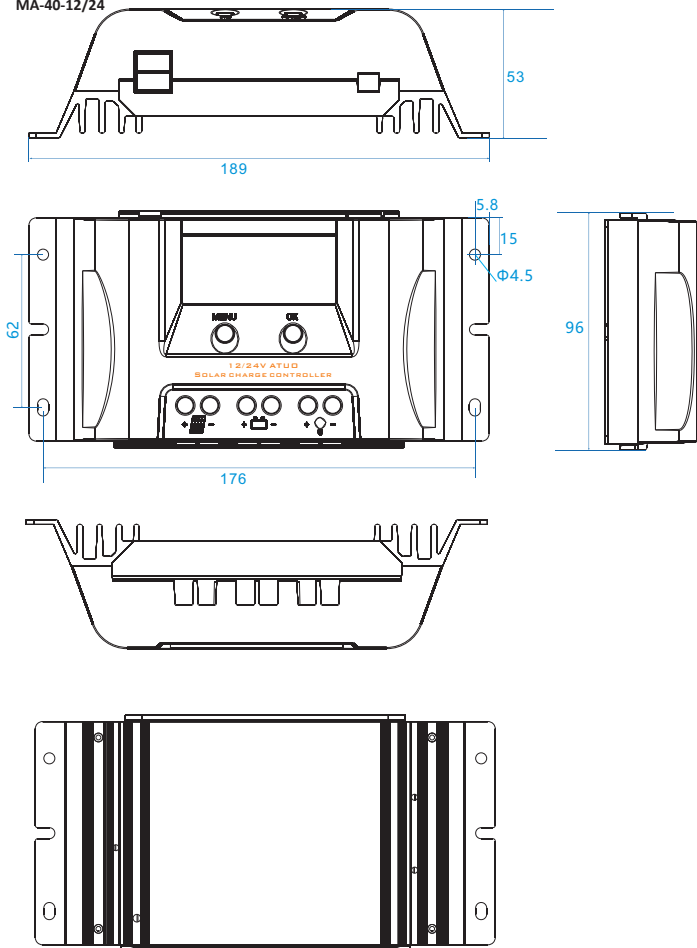

3.2  
MA-60-12/24  
MA-60-12/24/48

Unit:mm

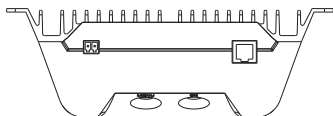
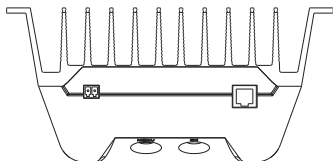
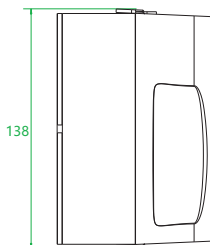
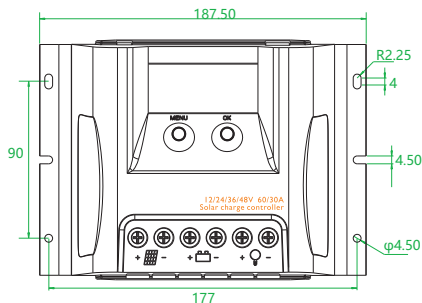
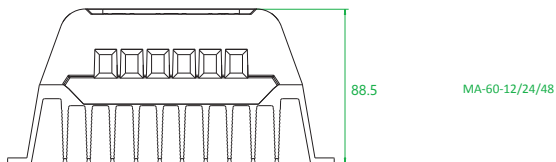
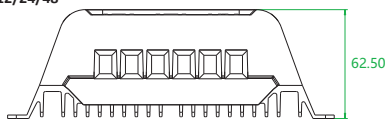

## 4, Structure & Accessory

### 4.1 Structure & Characteristics of MA-20-12/24, MA-30-12/24 and MA-40-12/24

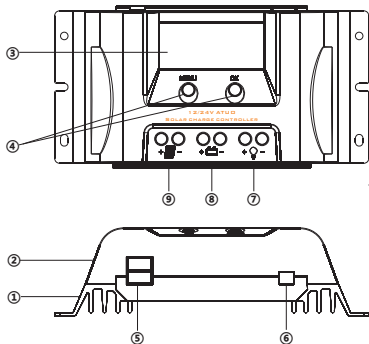

- ①Heat Sink  
—dissipate controller heat
- ②Plastic Case  
—Internal protection
- ③LCD  
—Display settings and operating status, system parameters
- ④Key: MENU, OK  
—Set and view the operating parameters
- ⑤Two USB interfaces  
—Output 5V, 2A
- ⑥Temperature Sensor Port  
—Collect temperature information, Temperature compensation.
- ⑦ Load Terminals  
—Connected load
- ⑧Battery Terminals  
—Connect the battery
- ⑨Solar module terminals  
—Connected solar modules

### 4.2 Structure & Characteristics of MA-60-12/24 and MA-60-12/24/48

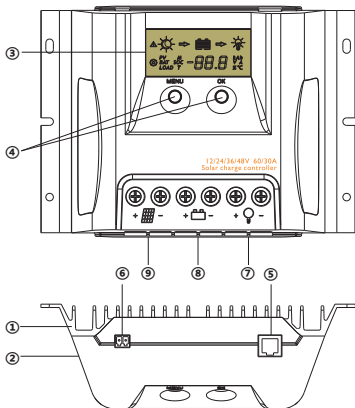

- ①Heat Sink  
—Dissipate controller heat
- ②Plastic Case  
—Internal protection
- ③LCD  
—Display settings and operating status, system parameters
- ④Key: MENU, OK  
—Set and view the operating parameters
- ⑤RJ11 interface  
—Connecting monitoring devices
- ⑥Temperature Sensor Port  
—Collect temperature information, Temperature compensation.
- ⑦ Load Terminals  
—Connected load
- ⑧Battery Terminals  
—Connect the battery.
- ⑨Solar module terminals  
—Connected solar modules

### 4.3 Temperature Sensor

To collect battery temperature data for temperature compensation so the controller can accurately charge the battery. The temperature sensor is connected via interface 6.

If the external temperature sensor is not connected or damaged, the controller defaults to the internal temperature information.

The controller is shipped with an 80 mm long cable temperature sensor. Should a sensor with a longer cable be required than this needs to be ordered separately.

### 4.4 RS485(only for MA-60-12/24 and MA-60-12/24/48)

The charger is equipped with a RS485 port with RJ11 sockets, the RJ11 interface is defined as follows:

Pin No.	Definition
1	NC
2	NC
3	RS485-A
4	RS485-B
5	NC
6	NC

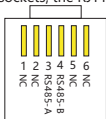

RJ11 for controller

 Protocol applicable to this controller: Modbus Communication Protocol V3.9



**The RS485 interface on this charger is not galvanically isolated and can not be grounded. Do not short circuit unused pin (Note NC).**

### 4.5 Option Accessories(only MA-60-12/24 and MA-60-12/24/48 are optional)

#### 4.5.1 Bluetooth Communication

MA-60-12/24 and MA-60-12/24/48 controllers can be connected to the Cyber-BT(bluetooth) via the RJ11 interface.

Bluetooth communication has the following characteristics :

1. Support mobile phone App
2. Realizes wireless monitoring function of PV charge controller
3. Use high performance, ultra-low power consumption Bluetooth dedicated chip
4. Adopt Bluetooth 4.0 and BLE technology



**1.This icon in this specification indicates that this solar controller has Bluetooth communication function.**

**2. Refer to Bluetooth APP instructions for detailed operation of mobile APP.**

#### 4.5.2 Wireless Communication for Internet of Things

The controller equipped with the Internet of Things wireless communication capability has the following characteristics:

1. For the wireless Internet of Things communication functionality the controller can be remotely accessed through IoT/GPRS.
2. A variety of options are available for remote monitoring and real-time control through WeChat App /PC program.
3. Real-time monitoring of PV voltage, PV charging current, battery voltage, battery current, load voltage, load current and other system parameters as well as charge controller status.
4. Real-time automatic fault alarm.

 **IoT Please contact our Sales Team for more details about the IoT wireless communication.**



## 5, Installation



**CAUTION:** Please read all instructions and precautions in the manual before proceeding with the installation! It is recommended to remove the protective film cover from the LCD screen before operation.

### 5.1 Installation Notes

- (1) This charge controller must only be used in PV systems in accordance with requirements given in this user manual and the specifications of other system components provided by their manufacturers. No energy source other than a PV generator may be connected to the PV charge controller referred herein.
- (2) PV-modules must always be disconnected prior to the installation and adjustments of the charge controller; Make sure the circuit breaker, fuse or disconnects of battery terminal are turned off.
- (3) Double check whether battery voltage meets the voltage range of Charge Controller.
- (4) Batteries store a large amount of energy, never short circuit a battery under any circumstances. We strongly recommend connecting a protection fuse directly to the battery terminal for protection in case of short circuiting the battery.
- (5) Batteries can produce flammable gases. Avoid provoking any sparks, using fire or any exposed flame close to any batteries, ever. Make sure that the battery room is well ventilated to disperse any gases.
- (6) Only use insulated tools and avoid placing (any) metal objects near/close to batteries.
- (7) Be extremely cautious when working with batteries. Wear eye protection by all means. Have fresh water available to immediately wash and clean any contact with battery acid. Get immediately medical aid in case of any hazard that may occur. Never install/handle with batteries alone.
- (8) Avoid touching or short-circuiting wires or terminals. Be aware that voltages on given system components, terminals or wires can be a multiple of battery voltage. Only use insulated tools, stand on dry ground, and keep your hands always dry and protected by proper (approved) electrician gloves when working on PV-Systems.
- (9) Prevent any water, ever, from penetrating the controller, outdoor installation must avoid any direct sunlight and penetration of any water (e.g. rain) and humidity.
- (10) After installation make sure that all connections are properly tighten, eliminate any electrical loose connections to eliminate by all means any hot electrical connection spots.

### 5.2 Mounting Location Requirements

Do not subject the PV charge controller to direct sunlight or any other heat sources. Protect the PV charge controller from any dust, dirt and moisture. Mount it flat to a vertical wall. Must be a non-flammable material. Maintain a minimum clearance of 15 cm below and around the controller to ensure unhindered air circulation. Mount the PV charge controller not too far from the batteries (for accurate voltage sensing least lessening).

Mark the position of the PV charge controller fastening holes on the wall, drill 4 holes and insert dowels, fasten the PV charge controller to the wall with the cable openings facing downwards.

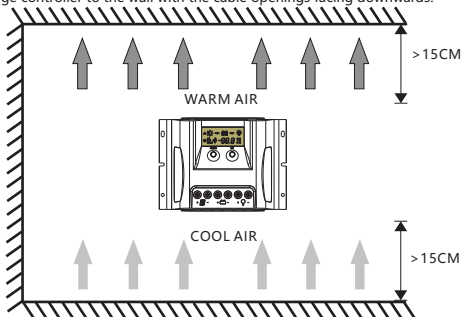

### 5.3 Wiring Specifications

Wiring and installation methods must comply with national and local electrical code/specifications.

The wiring specifications of the PV system battery must be selected according to rated currents. Please check following table for wiring specifications:

Model	Rated charging current	Rated discharging current	Solar wire diameter (mm <sup>2</sup> /AWG)	Battery wire diameter (mm <sup>2</sup> /AWG)	Load wire diameter (mm <sup>2</sup> /AWG)
MA-20-12/24	20A	20A	5/10	5/10	5/10
MA-30-12/24	30A	30A	6/9	6/9	6/9
MA-40-12/24	40A	40A	10/8	10/8	10/8
MA-60-12/24 MA-60-12/24/48	60A	30A	16/5	16/5	6/9

 The indicated cable/wire sizes are for reference only. If longer runs between the PV array and the controller or between the controller and the battery are required, than larger capacity cables must be used to reduce voltage drop and improve system performance.

### 5.4 Connection

We strongly recommend connecting a fuse directly to the battery terminal to protect from any short circuit in the battery circuit. PV-modules generate current whenever light shines on them. The generated current is directly proportional to the light intensity. Even low levels of light, will deliver the PV-Modules no load, full voltage. It is thus utterly advisable to protect PV-modules from any incident light during installation; Never touch uninsulated cables (ends), only use electric insulated tools, and make sure that the wire cross section is adequate for the PV module operating currents. Connections must always be conducted in the sequence as described below

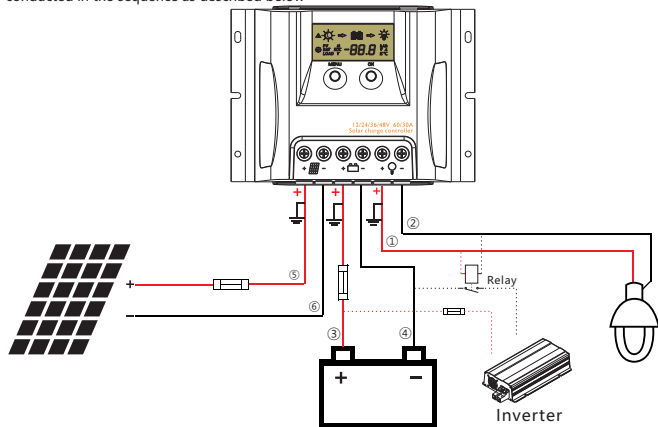

**WARNING:** The PV-module/array can produce open-circuit voltages in excess of 100 Vdc when exposed to sunlight. Pay highest attention to this fact.



**WARNING:** Risk of explosion! In case the battery's positive and negative terminals or leads get ever in touch, i.e. short-circuited, a fire or explosion hazard might get triggered. Always pay maximum when handling batteries and related circuits.



**CAUTION: 1. If no temperature sensor is connected to the controller, the battery temperature value will display the internal temperature.**

**2.If a power inverter is used the system, it should be connected to the battery via a DC relay. Do not connect it to the controller's load terminals.**

### **1st step: Connect loads**

Connect the load cable with the correct polarity of the right-hand side pair of terminals on the solar charge controller (with the lamp symbol). To avoid the presence of any tension on the cable/wires, please connect these first to the load before connecting them to the charge controller.

### **2nd step: Connect the battery**

Connect the battery cables observing the correct polarity to the center pair of terminals (make sure you identify the battery marking/symbol on the controller casing!) of the PV charge controller. Pay greatest attention to polarity. Never, ever invert the plus+ and minus- poles).

1)Should your system be nominal 12 Vdc, make sure the battery voltage is between the 10.0 and 15.0 Vdc voltage range;

2)for 24 Vdc nominal voltage, the battery voltage should be within the 20.0 to 30.0 Vdc range;

3)for 36 Vdc nominal voltage, the battery voltage should be within the 31.0 to 42.0Vdc;

4)for 48 Vdc nominal voltage, the battery voltage should be within the 42.0 to 62.0Vdc.

If the polarity is correct, the LCD on the controller will begin to display those.

### **3rd step: Connect the solar module**

When connecting the PV-Module make sure to cover it from incident sun light. Double check the PV-Module will not exceed the maximum permissible input current of the Charge Controller (please refer to the section Technical Data). Connect the solar module connection cable to the correct polarity of the left pair of terminals on the solar charge controller (with the solar module symbol).

### **4th step: Final work**

Tighten all cables connected to the controller and remove all the remains around the controller (leaving a void of minimum 15 cm).

## **5.5 Grounding**







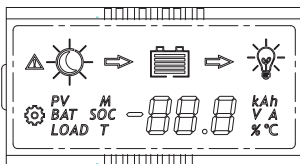











Be aware that the positive terminals of controller are interconnected and therefore bear the same electrical potential. If any grounding is required, always do this on the positive wires/terminals.

## 6, Operation

### 6.1 LCD Display



#### 6.1.1 Status Description

Item	Icon	Status
PV array	 	Daytime, not charging
	  	Daytime, charging
		Night
	<i>PV</i>	PV voltage, current and ampere hours
	<i>PV T</i>	The total charge ampere hours of the solar panel
Battery		Battery capacity
	 <i>BAT</i>	Battery voltage(Programmable LVD)
	<i>BAT</i>	Battery current
	<i>BAT SOC</i>	Battery state of charge(in %)
	 <i>25 °C</i>	Temperature(Clear external Bluetooth Device Password)
	 <i>BAT T GEL</i>	Battery type(Programmable)
Load	 <i>LOAD</i>	Load voltage(Programmable LVR) *
	<i>LOAD</i>	Load current and ampere hours
	<i>LOAD T</i>	The total discharge ampere hours of the load
	 <i>LOAD M</i>	Load mode(Programmable)
	  	The load is on
	 	The load is off
Fault		Fault indication, see 6.1.4

\* not able to set LVR for MA-20-12/24, MA-30-12/24 and MA-40-12/24

**PV array charge ampere hours and load ampere hours are off after power failure.**



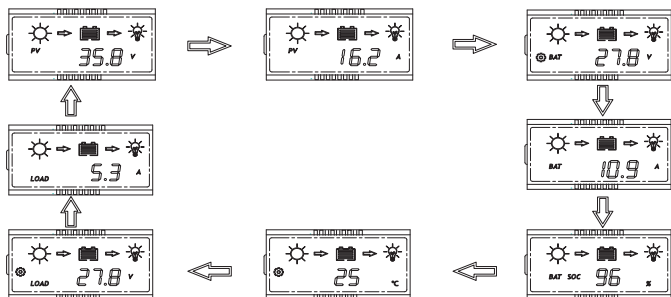



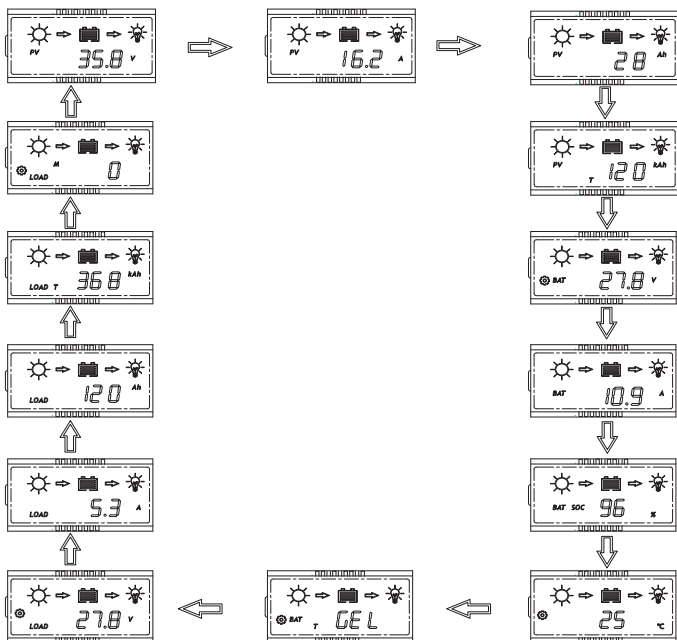



### 6.1.2 The interface automatically cycles in the displayed sequence



### 6.1.3 Press OK to browse the interface



### 6.1.4 Fault indication



Status	Icon	Description
Short circuit	  E1	Load off, fault icon display, load icon flashes, the LCD screen displays E1
Over current	  E2	Load off, fault icon display, load icon flashes, the LCD screen displays E2
Low voltage	  E3	Battery level shows empty, fault icon display, battery frame flashes, the LCD screen displays E3
Over voltage	  E4	Battery level shows full, fault icon display, battery flashes, the LCD screen displays E4
Over temperature	  E5	The charge and discharge are off, fault icon display, icon °C flashing, the LCD screen displays E5
Controller does not correctly identify system voltage	 E5	Controller does not correctly identify system voltage.

### 6.2 Key function





Mode	Operating
Browse interface	Short press <b>OK</b>
Static display	Press the <b>MENU</b> and <b>OK</b> key at the same time for 1s, the LCD screen will lock the interface. Press the <b>MENU</b> and <b>OK</b> key again for 1s, the LCD interface will unlock and start scrolling.
Setting parameter	Press the <b>MENU</b> key for 1s to enter the setting mode when the icon  appears on the display interface, and exit automatically after 30s
Load On/Off	When the controller is working in street lamp mode, press the <b>MENU</b> key for 3s to turn on the load, press the <b>MENU</b> key again or 1min later the load will be turned off.

## 6.3 Parameters setting

When the icon  appears in the display interface, it means that the parameters can be set. Press the **MENU** key for 1s, then icon  flashes, press **OK** to change the parameter.

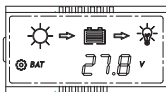
### 6.3.1 Low voltage protection(LVD)



When the LCD shows as displayed at left, press the **MENU** key for 1s, the icon  flashes, now you can set the controller's low voltage protection.

#### 1.Lithium Battery(MA-60-12/24 and MA-60-12/24/48)

Low voltage protection setting range:

12/24V: 9.0-30.0V (default: 10.6V)

12/24/36/48V: 9.0-60.0V (default: 21.0V).

#### 2.Liquid, Gel and AGM Battery

The low voltage protection of the controller can be divided into two types: battery voltage control and capacity control.

##### ①Battery voltage control

Low voltage protection setting range:

10.8~11.8V/21.6~23.6V/32.4~35.4V/43.2~47.2V(default: 11.2/22.4/33.6/44.8V).

##### ②Battery capacity control

Display	Low voltage protection range	Low voltage reconnect
S-1	11.0~11.6V/22.0~23.2V/33.0~34.8V/44.0~46.4V	12. 4/24. 8/37. 2/49. 6V
S-2	11.1~11.7V/22.2~23.4V/33.3~35.1V/44.4~46.8V	12. 5/25. 0/37. 5/50V
S-3	11.2~11.8V/22.4~23.6V/33.6~35.4V/44.8~47.2V	12. 6/25. 2/37. 8/50. 4V
S-4	11.4~11.9V/22.8~23.8V/34.2~35.7V/45.6~47.6V	12. 7/25. 4/38. 1/50. 8V
S-5	11.6~12.0V/23.2~24.0V/34.8~36.0V/46.4~48.0V	12.8/25.6/38.4/51.2V

### 6.3.2 Low voltage reconnect(LVR)

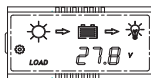

When the LCD shows as displayed at left, press the **MENU** key for 1s, the icon  flashes, you can set the controller's low voltage reconnect.

#### 1.Lithium Battery

Low voltage reconnect setting range is:

12/24V: 9.6-31.0V (default: 12.0V)

12/24/36/48V: 9.6-62.0V (default: 22.4V).

#### 2.Liquid, Gel and AGM Battery

Low voltage reconnect setting range:

11.4~12.8/22.8~25.6/34.2~38.4/45.6~51.2V(default : 12/24/36/48V).

**cannot set LVD, its LVD is 0.8/1.6v higher than LVR by default.**



The low voltage recovery voltage(LVR) should be higher than the low voltage protection voltage (LVD) at least 0.6/1.2/1.8/2.4V. If it is desired to improve LVD, than LVR must improved first.

### 6.3.3 Clear Bluetooth Device Password

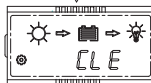
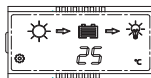

When the LCD shows as displayed at left, press the **MENU** key for 1s, the icon  flashes, you can press **OK** to clear the Bluetooth device password set by the mobile app.

 For device passwords, please refer to Bluetooth APP instructions.

### 6.3.4 Battery type

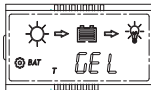

When the LCD shows as displayed at left, press the **MENU** key for 1s, the icon flashes, you can set the battery type.

Display	Battery type
GEL	GEL(Default)
L19	Liquid
AG-	AGM
LI	Lithium

#### 1.Charging Voltage Parameters(Liquid, GEL, AGM)

When choosing Liquid, GEL or AGM for battery type, the parameters of boost, equalization and float charge voltage can be set by IoT, RS485 or bluetooth APP. The range of parameters is as follows.

The following voltage parameters are 25°C/12V system parameters, 24/36/48V displayed values are multiplied by a factor of 2/3/4.

Charging stage	Boost	Equalization	Float
Charging Voltage Range	14.0~14.8V	14.0~15.0V	13.0~14.5V
Default charging voltage	14.5V	14.8V	13.7V

#### 2.Charging Voltage Parameters(Lithium)

The controllers are suitable for all kinds of lithium batteries. When choosing lithium battery type, the overcharge protection and overcharge recovery voltage of lithium battery can be set by IoT, RS485 or bluetooth APP.

Charge target voltage range: 12/24V: 10.0-32.0V (default:14.4V)  
12/24/36/48V: 10.0-64.0V (default:29.4V)

Charge recovery voltage setting range: 12/24V: 9.2-31.8V (default:14.0V)  
12/24/36/48V: 9.2-63.8V (default:28.7V)

**Note:** 1. MA-20-12/24, MA-30-12/24 and MA-40-12/24 cannot be set as a lithium battery controller.



2.  $(\text{Overcharge Recovery Voltage} + 1.5V) \geq \text{Lithium Overcharge Protection Voltage} \geq (\text{Overcharge Recovery Voltage} + 0.2V)$

Parameter setting out of range is not supported.



**Warning:** The required accuracy of BMS shall be at least 0.2V. If tolerance is larger than 0.2V, manufacturer will not assume any liability for any consequent system malfunction.

### 6.3.5 Load mode

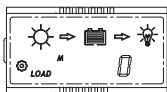

When the LCD shows as displayed at left, press the **MENU** key for 1s, the icon flashes, you can set the load mode.

Display	Load mode
0	Always on Mode: The load output is always switched on.
1	Dusk to Dawn Mode: The load output is switched on between sunset and sunrise.
2 3 4 5 6 7 8 9	Evening Mode: The load output will be switched on for 2~9hours after sunset.
USE	Manual Mode: The load output can be switched on and off manually by pressing <b>MENU</b> shortly.

#### 1.Always on Mode

When the controller is set to always On mode, no matter the charging or discharging state, the load is always powered on (except in protection state).



## 2. Street lamp Function

When the load is set to Dusk to Dawn or Evening mode, the Day/Night threshold voltage and the Day/Night delay time can be set by IoT, RS485 or bluetooth APP, and the load can be turned on or off by the test function during the day charging process.

### 2.1 Day/Night threshold voltage

The controller recognizes day and night based on the solar array open circuit voltage.

This day/night threshold voltage can be modified according to local light conditions and the solar array used. **MA-20-12/24, MA-30-12/24 and MA-40-12/24 defaults to 5.0/10.0V.**

Day/Night threshold setting range: 3.0~10/6.0~20/9.0~30.0/12~40V(Default: 8/16/24/32V)

### 2.2 Day/Night delay time

In the evening, when the solar array open circuit voltage reaches the setting day/night detect voltage, you can adjust the day/night delay time to make the load turn on a little bit later.

Day/Night delay time setting range: 0~30min(Default: 0min)

### 2.3 Test Function

When the controller is working in Dusk to Dawn or Evening mode, press the **MENU** key for 3s to turn on the load. Press the **MENU** key again or the load turns off automatically after 1 minute.

If the controller is operating in always on mode, the test function does not work.

## 3. User-definde Mode

①If the load mode is selected "**USE**", then you can switch on and off the load output manually by pressing **MENU** shortly.

②The default switching state of the load in manual mode can be changed by IoT, RS485 or bluetooth APP. At the same time, the output to the load can be turned on or off.



**1.If the controller turns off the load due to low voltage protection, overcurrent protection, short-circuit protection or over temperature protection, the load will turn on automatically when the controller recovers from protection state.**

**2.Please note: Pushing the MENU button can still activate the function of the key, even during of the above four kinds protection states.**









## 6.4 USB interface(MA-20-12/24, MA-30-12/24 and MA-40-12/24)

MA-20-12/24, MA-30-12/24 and MA-40-12/24 have two USB interfaces, maximum output of single USB is 5V 1.5A, maximum output of two USB is 5V 2A, for charging mobile phones and other smart devices.

The USB stops output only when the controller is in low voltage protection.

# 7, Troubleshooting, Protections and maintenance

## 7.1 Troubleshooting

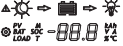
Faults	Reason	Troubleshooting
  E1	Short Circuit	Switch off all loads, remove short circuit, load will be reconnected after 1 minute automatically
  E2	Over Current	Reduce the load, the controller will resume work after 1minute.
  E3	Battery voltage is too low	Load will be reconnected when battery is recharged
  E4	Battery voltage is too high	Check if other sources overcharge the battery. If not, controller is damaged.
 °C E5	Over temperature	After the temperature decreases, the controller will work normally
	Battery voltage is abnormal at start-up	Charge or discharge the battery so that the battery voltage is within the normal operating range (10~15V or 20~30V or 31~42 or 42~62V)
Battery can't be charged during daytime	PV panel fault or reverse connection	Check panels and connection wires

## 7.2 Protection

Protection	Description
Charging over current	The controller will limit charging current on battery to the rated level.
PV Short Circuit	When PV short circuit occurs, the controller will stop charging. Remove it to resume normal operation.
PV Reverse Polarity	Fully protection against PV reverse polarity, no damage to the controller. Correct the connection to resume normal operation.
Battery Reverse Polarity	Fully protection against battery reverse polarity, no damage to the controller. Correct the connection to resume normal operation.
Battery Over voltage	Should there are other energy sources to charge the battery, when the battery voltage exceeds 15.8 / 31.3 / 46.8 / 62.3V(Overcharge protection voltage of lithium battery equals target voltage plus 0.2V), the controller will stop charging to protect the battery from overcharging damage.
Battery Over discharge	When battery voltage drops to the low voltage disconnect setting, the controller will stop discharging to protect the battery from over discharging damage.
Load Over Current Protection	If the load current exceeds the maximum load current rating 1.25 times, the controller will disconnect the load.
Load Short Circuit Protection	Once the load short circuit happens , the load short circuit protection will trigger automatically.
Over Temperature Protection	The controller detects the internal temperature through internal sensor, when the temperature exceeds the setting value, the charging current will decrease, and consequently, the controllers temperature; Should controllers temperature rise and approach over temperature protection threshold, the controller will stop its operation and resume after temperature lowers/returns to an acceptable level.
Damaged Remote Temperature Sensor	Should the temperature sensor be short-circuited or damaged, the controller will be charging or discharging at the internal temperature automatically to prevent the battery damaged from overcharging or over discharged.

**Two or more errors at the same time can damage the controller, so you must troubleshoot the existing fault .**

## 7.3 Maintenance

For best system performance, the following inspections and maintenance tasks are recommended to be carried out for at least two times a year.

- Make sure no block on air-flow around the controller. Clear up any dirt and fragments on radiator.
- Check all the naked wires to make sure insulation is not damaged. Repair or replace some wires if necessary.
- Tighten all terminal screws to the indicated torque; Inspect for loose, broken, or burnt cable/wire connections.
- Check and confirm that LCD is consistent with required. Pay attention to any troubleshooting or error indication. Take corrective action if necessary.
- Make sure all system components are effectively and tightly connected to ground.
- Check all terminals for any corrosion signs, damaged insulation, increased temperature or carbonization/discholoring signs.
- Check for any dirt, nesting insects and any corrosion signs. Implement corrections actions as early as possible.



**WARNING: Risk of electric shock!**

**Make sure that all the power is turned off before above operations, and then follow the corresponding inspections and operations.**

## 8, Technical Data

	Item	MA-20-12/24	MA-30-12/24	MA-40-12/24
Battery Parameters	System Voltage	12V/24V automatical recognition		
	Max Charging Current	20A	30A	40A
	Fast Voltage	<14.5/29.0V@25°C		
	Boost Voltage	14.5/29.0V @25°C		
	Equalization Voltage	14.8/29.6V @25°C (Liquid, AGM)		
	Float Voltage	13.7/27.4V @25°C		
	Low Volt. Disconnect	10.8~11.8V/21.6~23.6V, SOC1~5 (default: 11.2/22.4V)		
	Reconnect Voltage	11.6~12.8V/23.2~25.6V (default: 12.0/24.0V)		
	Overcharge Protect	15.5/31.0V		
	Max volt on Bat. terminal	35V		
	Temp. Compensation	-4.17mV/K per cell (Boost, Equalization), -3.33mV/K per cell (Float)		
	Battery Type	Liquid, Gel, AGM (default: Gel)		
Panel Parameters	Max volt on PV terminal	55V		
	Dusk/Dawn detect volt.	5.0/10.0V		
Load	Output Current	20A	30A	40A
	USB interface	5V, 2A		
	Load mode	Always on, Dusk to Dawn, Evening, Manual		
System Parameters	Dimensions	189 * 96 * 53mm		
	Weight	420g		
	Self consumption	5mA		
	Grounding	Common positive		
	Power terminals	8AWG(10mm <sup>2</sup> )		
	Ambient temperature	-20 ~ +50°C		
	Storage temperature	-25 ~ +80°C		
	Ambient humidity	0 ~ 100%RH		
	Protection degree	IP32		
	Max Altitude	4000m		

\* Around oblique line value separately on behalf of 12V and 24V system's value.

	Item	MA-50-12/24	MA-60-12/24	
Battery Parameters	Max Charging Current	50A	60A	
	System Voltage	12/24V automatic recognition		
	Max volt on Bat. terminal	35V		
	Battery Type	Gel, AGM, Liquid, Lithium (default: Gel)		
	Liquid, Gel and AGM	Fast Charging Voltage	before boost or equalization charging stage	
		Boost Voltage	14~14.8/28~29.6V @25°C(default: 14.5/29V)	
		Equalization Voltage	14~15.0/28~30V@25°C(default: 14.8/29.6V)(Liquid, AGM)	
		Float Voltage	13~14.5/26~39V @25°C(default: 13.7/27.4V)	
		Low Volt. Disconnect	10.8~11.8V/21.6~23.6V(default: 11.2/22.4V)	
		Reconnect Voltage	11.4~12.8V/22.8~25.6V (default: 12.0/24.0V)	
		Overcharge Protect	15.8/31.3V	
	Lithium	Temp. Compensation	-4.17mV/K per cell (Boost, Equalization), -3.33mV/K per cell (Float)	
		Charging target voltage	10.0~32.0V(Lithium, default: 14.4V)	
		Charging recovery voltage	9.2~31.8V(Lithium, default: 14.0V)	
Low voltage disconnect		9.0~30.0V(Lithium, default: 10.6V)		
	Low voltage reconnect	9.6~31.0V(Lithium, default: 12.0V)		
Panel Parameters	Max volt on PV terminal *1	55V		
	Day/Night threshold	Lithium: 3.0~20.0V(Programmable) Gel, AGM and Liquid: 3.0~10.0/6.0~20.0V(Programmable)		
	Day/Night delay Time	0~30min		
Load	Output Current	30A		
	Load mode	Always on(Default) , Street lamp, User-defind Mode		
System Parameters	Dimensions	138*187.5*62.5mm		
	Weight	720g		
	Self consumption	10mA		
	Communication	RS485(RJ11 interface)		
	Optional	IoT, Cyber-BT		
	Grounding	Common Positive		
	Power terminals	6AWG(16mm²)		
	Ambient temperature	-20 ~ +55°C		
	Storage temperature	-25 ~ +80°C		
	Ambient humidity	0 ~ 100%RH		
	Protection degree	IP32		
Max Altitude	4000m			

\*1. Maximum solar panel voltage at minimum ambient operating temperature.

\*2. Around oblique line value separately on behalf of 12V and 24V system's value.

	Item	MA-50-12/24/48	MA-60-12/24/48	
Battery Parameters	Max Charging Current	50A	60A	
	System Voltage	12/24/36/48V automatic recognition		
	Max volt on Bat. terminal	65V		
	Battery Type	Gel, AGM, Liquid, Lithium (default: Gel)		
	Liquid, Gel and AGM	Fast Charging Voltage	before boost or equalization charging stage	
		Boost Voltage	14~14.8/28~29.6/42~44.4/56~59.2V@25°C (default:14.5/29/43.5/58V)	
		Equalization Voltage	14~15/28~30/42~45/56~60V@25°C (default:14.8/29.6/44.4/59.2V)(Liquid, AGM)	
		Float Voltage	13~14.5/26~29/39~43.5/52~58V@25°C (default:13.7/27.4/41.1/54.8V)	
		Low Volt. Disconnect	10.8~11.8/21.6~23.6/32.4~35.4/43.2~47.2V (default:11.2/22.4/33.6/44.8V)	
		Reconnect Voltage	11.4~12.8/22.8~25.6/34.2~38.4/45.6~51.2V (default:12/24/36/48V)	
		Overcharge Protect	15.8/31.3/46.8/62.3V	
	Temp. Compensation	-4.17mV/K per cell (Boost, Equalization), -3.33mV/K per cell (Float)		
	Lithium	Charging target voltage	10.0~64.0V(Lithium, default: 29.4V)	
Charging recovery voltage		9.2~63.8V(Lithium, default: 28.7V)		
Low voltage disconnect		9.0~60.0V(Lithium, default: 21.0V)		
Low voltage reconnect		9.6~62.0V(Lithium, default: 22.4V)		
Panel Parameters	Max volt on PV terminal *1	100V		
	Day/Night threshold	Lithium: 3.0~40.0V Gel, AGM and Liquid: 3~10/6~20/9~30/12~40V		
	Day/Night delay Time	0~30min		
Load	Output Current	30A		
	Load mode	Always on(Default) , Street lamp, User-defind Mode		
System Parameters	Dimensions	138*187.5*88.5mm		
	Weight	1.1Kg		
	Self consumption	10mA (12/24V); 7mA (36/48V)		
	Communication	RS485(RJ11 interface)		
	Optional	Cyber-BT		
	Grounding	Common Positive		
	Power terminals	6AWG(16mm <sup>2</sup> )		
	Ambient temperature	-20 ~ +55°C		
	Storage temperature	-25 ~ +80°C		
	Ambient humidity	0 ~ 100%RH		
	Protection degree	IP32		
Max Altitude	4000m			

\*1. Maximum solar panel voltage at minimum ambient operating temperature.

\*2. Around oblique line value separately on behalf of 12V, 24V, 36V and 48V system's value.